

TM-2657P

Automatic Blood Pressure Monitor

Instruction Manual

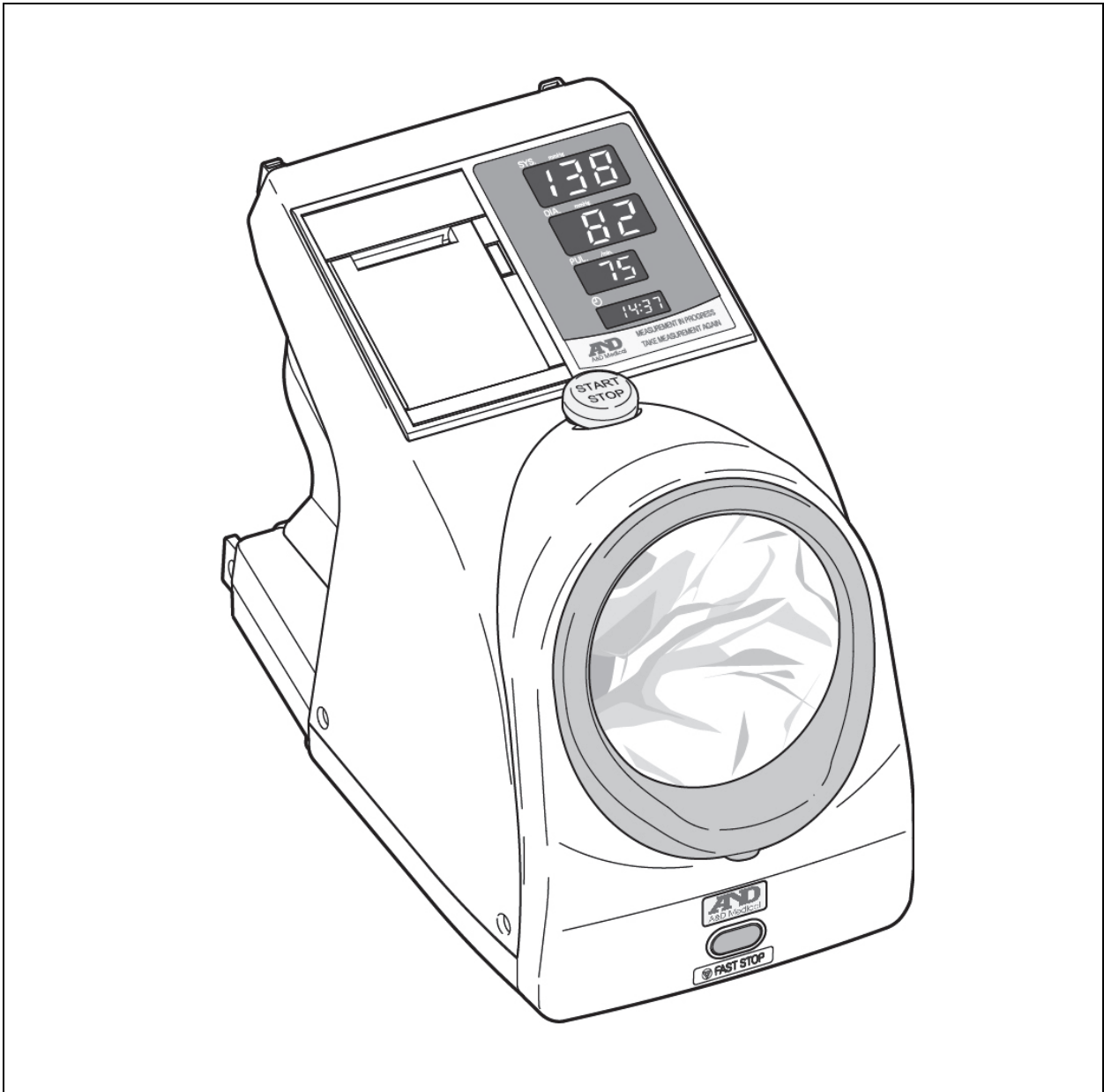

A&D
A&D Medical

© 2015 A&D Company, Limited. All rights reserved.

No part of this publication may be reproduced, transmitted, transcribed or translated into any language in any form by any means without the express written consent of A&D Company, Limited.



The contents of this manual and the specifications of the instruments covered by this manual are subject to change without notice.

Windows is a registered trademark of the Microsoft Corporation.



WARNING DEFINITIONS

To prevent accidents due to inappropriate handling, this product and its manual contain the following warning signs and marks. The meaning of these warning signs and marks are as follows.

Warning Definitions

 Danger	An imminently hazardous situation which, if not avoided, will result in death or serious injury.
 Warning	A potentially hazardous situation which, if not avoided, could result in death or serious injury.
 Caution	A potentially hazardous situation which, if not avoided, may result in minor or moderate injury. It may also be used to alert against unsafe practice.

Symbol Examples

	<p>The symbol \triangle indicates "Caution."</p> <p>The nature of the caution required is described inside or near the symbol, using text or a picture.</p> <p>The example on the left indicates caution against electrical shock.</p>
	<p>The symbol \ominus indicates "Do not."</p> <p>The prohibited action is described inside or near the symbol, using text or a picture.</p> <p>The example on the left indicates "Do not disassemble."</p>
	<p>The symbol \bullet indicates mandatory action.</p> <p>The mandatory action is described inside or near the symbol, using text or a picture.</p> <p>The example on the left indicates general mandatory action.</p>

Other



Note	Provides information useful for the user to operate the device.
-------------	---



Precautions for each operation are described in the instruction manual. Read the instruction manual before using the device.

PRECAUTIONS FOR USE

In order to use the TM-2657P Automatic Blood Pressure Monitor safely and correctly, carefully read the following precautions before using the monitor. The following content summarizes general matters regarding the safety of patients and operators, in addition to safe handling of the monitor.



1. When installing and storing the monitor.



 Danger	
	Keep the monitor away from areas where flammable anesthetics or flammable gases are present, high-pressure oxygen chambers, and oxygen tents. Using the monitor in these areas may cause an explosion.

 Caution	
	<p>Consider the following when using and storing the monitor. If the monitor is stored in an environment beyond the specified temperature or humidity, it may not perform to its capabilities.</p> <ul style="list-style-type: none">■ Avoid locations where the monitor may be splashed by water.■ Avoid locations with high temperature, high humidity, direct sunlight, dust, salt and sulfur in the air.■ Avoid locations where the monitor may be tilted, vibrated, or impacted (including during transportation).■ Avoid locations where chemicals are stored or gas occurs.■ Avoid locations where removal and insertion of AC power cable is prohibited.■ Installation site: A location with a temperature between +10°C and +40°C and a humidity between 15% RH and 85% RH (no condensation).■ The surface temperature of the cuff may become 46°C when used in a 40 °C environment.■ Storage site: A location with a temperature between -20°C and +60°C and a humidity between 10% RH and 95% RH.■ A location with an electrical outlet that can supply sufficient power (frequency, voltage, current) for the monitor.



Note	
■ Please be aware that the rubber feet may discolor the top of the stand.	



2. Before using the monitor.

 Warning	
 	<ul style="list-style-type: none">■ Make sure that the electrical outlet is properly grounded and supplies the specified voltage and frequency (100-240V~ 50-60 Hz, more than 85VA).■ Connect the monitor to a grounded, 3-prong outlet. If a grounded, hospital-grade, 3-prong outlet is not available, connect the ground wire to an outlet with a contact terminal and ground it. Using the monitor with an incorrect outlet may cause an electrical shock.





 Caution	
	<ul style="list-style-type: none"> ■ Use the monitor safely and correctly. ■ Connect all cables correctly and securely. ■ Do not place objects on the monitor or power cable. ■ Ensure cuff cover is fitted before use. ■ Using other devices in conjunction with this monitor may cause incorrect diagnosis or safety problems. When used, check for safety. ■ Always use accessories and consumables approved by A&D. ■ Carefully read the instruction manuals provided with optional items. The precautions for these items are not listed in this manual. ■ For safe and correct use of this monitor, always perform a pre-inspection (an inspection before use). ■ If the monitor is covered with condensation, allow it to dry before switching the power on. ■ If the monitor has not been used for an extended period, check that the monitor operates normally and safely before using it. ■ The pressure of the cuff may cause a patient's arm to become numb.

3. When using the monitor.



 Warning	
	<ul style="list-style-type: none"> ■ Do not use a mobile phone near the monitor. It may cause a malfunction. ■ Do not use the monitor in a moving vehicle as this may result in inaccurate measurements.

 Caution	
	<ul style="list-style-type: none"> ■ Always check the condition of the monitor, its parts and the patient for safety. ■ If a problem is found with the monitor, its parts or the patient, stop using the monitor, check the status of the patient and take appropriate actions. ■ Do not use the monitor near a strong magnetic or electric field. ■ Do not use the monitor on a patient using a heart-lung machine. ■ Ensure that the air hose in the device is not bent or blocked. If a cuff with a kinked or bent air hose is used, clotting may occur in the arm from the remaining air in the cuff, resulting in potential peripheral circulatory failure. ■ Frequent measurements can cause injury to the patient by interfering with blood flow. ■ Check the condition of the patient on a regular basis if measurements are performed frequently for a long time. There is a risk of causing damage by interfering with blood flow. ■ To ensure accurate measuring, we recommend measuring blood pressure after being in a relaxed state for at least five minutes.



4. After using the monitor.



 Caution	
	<ul style="list-style-type: none">■ Use the specified procedure to return switches to their state before usage, then switch the power off.
	<ul style="list-style-type: none">■ Do not forcibly pull out the cables. Hold the connector with your hand when disconnecting the cables.
	<ul style="list-style-type: none">■ Clean the accessories and arrange them before storage.■ Keep the monitor clean and in proper operating condition so that it can be used without problem for the next operation.

5. If you suspect there is a problem with the monitor, perform the following actions.



 Warning	
	<ul style="list-style-type: none">■ Ensure the safety of the patient.■ Stop the operation of the monitor, switch the power off, and then disconnect the power cable from the outlet.■ If the air in the cuff is not released by pressing the START/STOP switch, press the FAST STOP switch.■ Label the monitor with a sign that says “Out of order” or “Do not use” and then contact A&D immediately.

6. When performing a maintenance inspection.

 Warning	
	<ul style="list-style-type: none">■ For your safety, before performing a maintenance inspection, switch the power off and disconnect the power cable from the outlet.■ If the monitor has not been used for an extended period, check that the monitor operates normally and safely before using it.■ Always perform a pre-inspection and maintenance inspection to ensure safe and correct operation. The organization that installs the monitor (hospital, clinic) is responsible for use, maintenance, and management of medical electrical devices. Neglecting pre-inspection and maintenance inspection can result in accidents.
	<ul style="list-style-type: none">■ Never disassemble or modify the monitor (medical electrical device).

 Caution	
	<ul style="list-style-type: none">■ When maintaining the monitor, use a dry, soft cloth. Do not use rags soaked in volatile liquids such as thinner and benzene.

7. Be aware that strong electromagnetic waves can cause malfunctions.



 Caution	
	<ul style="list-style-type: none">■ This monitor complies with EMC-standard IEC60601-1-2:2007. However, to prevent electromagnetic interference with other devices, do not use mobile phones near the monitor.■ If this monitor is located near strong electromagnetic waves, noise may enter in waveforms and malfunctions may occur. If unexpected malfunctions occur during use of this monitor, inspect the electromagnetic environment and take appropriate actions. <p>The following are examples of general causes and countermeasures.</p> <ul style="list-style-type: none">■ Use of mobile phones Radio waves may cause unexpected malfunctions.<ul style="list-style-type: none">□ Instruct visitors to rooms or buildings with medical electrical devices not to use mobile phones or small wireless devices.■ High frequency noise is being introduced from other devices via the electrical outlet.<ul style="list-style-type: none">□ Check for the source of noise, and then perform countermeasures, such as using a noise cancellation device on this line.□ If the noise source is a device that can be stopped, stop using it.□ Use another electrical outlet.■ Effects from static electricity are suspected (discharges from devices or the surrounding area)<ul style="list-style-type: none">□ Before using the monitor, ensure that the operator and patient have discharged static electricity.□ Humidify the room.■ If lightning is occurring nearby, the monitor may receive excessive voltage. In such cases, power the monitor using the following method.<ul style="list-style-type: none">□ Use an uninterruptible power supply.



8. Environmental considerations

 Caution	
	Before disposing of this monitor, remove the lithium battery from the monitor.

PRECAUTIONS FOR SAFE MEASUREMENT

The following lists precautions related to measurement. Always consult with a doctor for evaluation of the results and treatment. Self-diagnosis and self-treatment from results can be dangerous.

 Warning	
	Do not measure on an arm receiving an intravenous drip or blood transfusion. This may cause an accident.
	<ul style="list-style-type: none"> ■ If the arm cuff cover is soiled with blood, dispose of the cover. There is a risk of spreading disease. ■ Items that may be contaminated must be disposed of as medical waste. ■ Do not perform measurement if the arm has external injuries. Not only will the wound worsen, there is a risk of spreading disease.

 Caution	
	<ul style="list-style-type: none"> ■ Measurement cannot be performed in the following cases. <ul style="list-style-type: none"> □ The patient who has thin or thick arms. <ul style="list-style-type: none"> • Measurement is intended for arms with circumferences of 18 to 35 cm. □ The arm of the patient is wet. <ul style="list-style-type: none"> • Wet arms may cause accidents or electrical shock.

Note	
<ul style="list-style-type: none"> ■ Blood pressure measurement may cause subcutaneous bleeding. This subcutaneous bleeding is temporary and disappears with time. ■ If thick clothing is worn, correct measurement is not possible. Measure when the patient is wearing a sleeveless or thin shirt. ■ If the patient rolls up their sleeve and this pinches their arm, correct measurement is not possible. ■ Measurement is not possible with patients with peripheral hypoperfusion, very low blood pressure, or low body temperature (since blood flow to the measurement location is low). ■ Measurement is not possible with patients with frequent arrhythmia recurrences ■ Measurement locations are restricted to the right and left upper arms. Other locations cannot be measured. ■ Insert the arm into the arm insertion section up to the top of the shoulder. ■ If the patient does not feel well, stop measurement immediately and take appropriate actions. ■ Measurement cannot be performed with the following patients. <ul style="list-style-type: none"> □ Patients who have just exercised <ul style="list-style-type: none"> • Blood pressure after exercise is higher than normal. Measure after the patient has rested for several minutes and has taken deep breaths. □ Patients with shaking arms <ul style="list-style-type: none"> • If the patient's body moves, correct measurement is not possible. Wait until the shaking stops, and then perform measurement. (This includes shaking from the cold or muscle movements after moving heavy objects.) ■ Consult the doctor for any of the following situations. <ul style="list-style-type: none"> □ The application of the cuff on any limb with intravascular access or therapy, or an arteriovenous (A-V) shunt. □ The application of the cuff on the arm on the side where a mastectomy has been performed. □ Simultaneous use with other medical monitoring equipment on the same limb. □ The blood circulation of the patient needs to be checked. 	

UNPACKING

Caution



- This monitor is a precision device and must be handled carefully. If it receives a strong impact, it may be damaged.

Note

- This monitor has been shipped in specially designed packaging to prevent damage during shipping. Check the monitor for damage when unpacking it.

Before using the monitor, ensure that everything is included and then check the main unit and each standard accessory for damage.

For optional items, see “13. ACCESSORIES AND OPTIONS LIST”.

Main unit	1
Standard accessories	
Power cable	1
Arm cuff cover	1 (One already installed on the main unit)
Printer paper	1
Instruction manual (this manual)	1
Instruction panel	1



Main unit

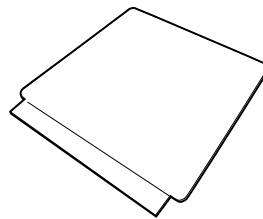

Instruction panel

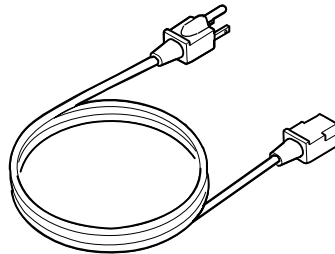

Power cable

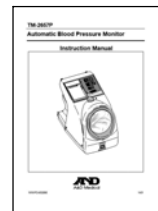

Instruction manual

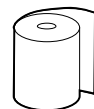

Printer paper (1 roll)

[Blank page]

TABLE OF CONTENTS

1. INTRODUCTION.....	3
2. FEATURES.....	3
3. ABBREVIATIONS AND SYMBOLS.....	4
4. SPECIFICATIONS.....	6
4.1. MODEL CONFIGURATION.....	6
4.2. PERFORMANCE SPECIFICATIONS.....	6
4.3. EXTERNAL DIMENSIONS.....	7
4.4. OPERATION PRINCIPLES.....	7
4.5. STANDARDS AND COMPLIANCES.....	7
5. PART NAMES.....	8
6. BEFORE USE.....	11
6.1. MONITOR INSTALLATION.....	11
6.2. POWER CONNECTION.....	11
6.3. SECURITY SLOT.....	11
6.4. ATTACHING THE INSTRUCTION PANEL.....	12
6.5. PRE-INSPECTION.....	13
7. BLOOD PRESSURE MEASUREMENT.....	14
8. SETTING THE CLOCK.....	15
9. PRINTER.....	16
9.1. INSTALLING THE PRINTER PAPER.....	16
9.2. SELECTING THE PRINT FORMAT.....	18
10. CHANGING FUNCTIONS.....	20
10.1. CHANGING PROCEDURE.....	20
10.2. DISPLAY TIME.....	23
10.3. APPLIED PRESSURE.....	23
10.4. IHB.....	23
10.5. PRINT QUALITY.....	24
10.6. ID AND NAME PRINTING.....	24
10.7. MEAN ARTERIAL BLOOD PRESSURE (MAP) PRINTING.....	25
10.8. MEASUREMENT VALUE PRINTING.....	26
10.9. GRAPH PRINTING.....	27
10.10. BITMAP PRINTING.....	27

10.11.	BEEP SOUND	27
10.12.	EXTERNAL INPUT/OUTPUT PROTOCOL.....	28
10.13.	TRANSMISSION SPEED (MINI-DIN).....	29
10.14.	TRANSMISSION SPEED (D-SUB).....	29
10.15.	STOP BIT (MINI-DIN).....	29
10.16.	STOP BIT (D-SUB)	29
10.17.	BLOOD PRESSURE RESULT OUTPUT.....	29
10.18.	DATE FORMAT	30
10.19.	TIME FORMAT.....	30
10.20.	ICT PRINTING	30
10.21.	BLUETOOTH CONNECTION TIMING.....	31
11.	TRANSMISSION SPECIFICATIONS	32
11.1.	EXTERNAL INPUT/OUTPUT UNIT.....	32
12.	MAINTENANCE.....	41
12.1.	INSPECTION AND SAFETY MANAGEMENT.....	41
12.2.	CLEANING	43
12.3.	PERIODIC INSPECTION	46
12.4.	REPLACING THE ARM CUFF COVER.....	47
12.5.	CHECKING THE NUMBER OF MEASUREMENTS.....	49
12.6.	DISPOSING OF THE COMPONENT PARTS.....	50
12.7.	BEFORE REQUESTING SERVICE	51
12.8.	ERROR CODES	52
13.	ACCESSORIES AND OPTIONS LIST.....	55
14.	ABOUT BLOOD PRESSURE.....	55
15.	SENDING BITMAP PATTERNS.....	56
15.1.	SIZE OF ORIGINAL BITMAP PATTERNS	56
15.2.	SENDING BITMAPS	57
APPENDIX: EMC INFORMATION.....		58

1. INTRODUCTION

This device conforms to the European Directive 93/42/EEC for Medical Products. This is evidenced by the CE mark of conformity accompanied by the reference number of a designated authority.

This device is a blood pressure monitor that measures systolic and diastolic blood pressure and pulse rate for diagnosis and checkup. The intended users are general adults, or 13 and older, with common knowledge about blood pressure measurement, who can perform a measurement on either their right or left arm.

This device is designed to be used at outpatient clinics of general hospitals. It can also be used at health facilities, fitness gyms and other public facilities for blood pressure management of the visitors.





















Notes

- Do not attempt to evaluate the blood pressure measurement results. Always consult with a doctor for evaluation of the results and treatment, especially when the results are greatly different from your ordinary values. Self-diagnosis and self-treatment from such results can be dangerous.
- Do not attempt to use this device on newborns or infants. Using this device on small children could cause injury to them. This device is designed for measuring adults.
- Facilities with the device installed should employ at least one person who has good knowledge of blood pressure measurement and can give advice to users about how to pose for measurement or general information about blood pressure. The person should also have basic knowledge about maintenance of the monitor and know procedures to request training for maintenance if necessary.

2. FEATURES

- Measurement can be performed using either the right or left arm.
- The arm cuff is inflated around the arm by pressing the **START/STOP** button and deflation speed is automatically controlled. No special adjustment is required. All you have to do is insert your arm into the arm insertion section to the shoulder and press the **START/STOP** button. The rest of the procedure is done automatically for a quick and easy measurement of blood pressure.
- The printer is equipped with a cutter to automatically cut the printed paper.
- An optional external input/output unit can be connected to a computer for data management or automation as necessary.

3. ABBREVIATIONS AND SYMBOLS

Abbreviation/ Symbol	Meaning
	Alternating current
mmHg	Blood pressure unit
/min.	Heartbeats per minute
---	Displayed when measurement is not possible
SYS	Systolic blood pressure (Used for table printing)
MAP	Mean arterial blood pressure (Used for printing, depending on settings)
DIA	Diastolic blood pressure (Used for table printing)
PUL	Pulse (used for table printing)
	Measurement time (used for table printing)
“♥”	Irregular Heartbeat symbol (IHB) Appears when an irregular heartbeat is detected. The mark is printed when a very slight vibration like shivering or shaking is detected. Read the description about irregular heartbeat on the next page.
	Power off (disconnected from the power source)
	Power on (connected to the power source)
SN	Serial number
20XX 	Date of manufacture
	RS-232C serial interface
	EC directive medical device label
	WEEE label
	EU authorized representative
	Manufacturer
Exx	Error code display (xx=00 to 99)
	Displays extent of electric shock protection: B-type applied part
	Follow Instructions for use
	Displays the measurement status. "MEASUREMENT IN PROGRESS".
	Displays the measurement status. "TAKE MEASUREMENT AGAIN"
	FAST STOP for rebooting the device.
	Caution: "Please do not pull printer paper during printing."
	Caution: "The printer paper is automatically cut."
	"POWER" switch.
	Used to change functions.
	Used to change function setting.
	Used to display the number of measurements to date.
	Describes how to change printer paper.

What is IHB (Irregular Heartbeat)?

The TM-2657P blood pressure monitor provides a blood pressure and pulse rate measurement even when an irregular heartbeat occurs. An irregular heartbeat is defined as a heartbeat that varies by 25% from the average of all heartbeats during the blood pressure measurement. It is important that you are relaxed, remain still and do not talk during measurement.

25% or shorter than average

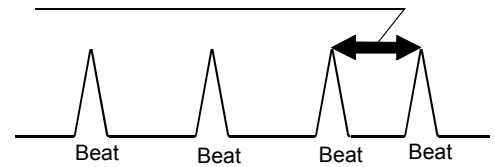

Note

- We recommend that the patient sees a doctor or clinician if the symbol (“♥”) frequently.

When is the IHB mark printed?

The IHB mark is printed in the measurement data in the following two cases.

- When a beat varies by $\pm 25\%$ from the average pulse interval during measurement.
- When the arm or monitor is moved during measurement.

4. SPECIFICATIONS

4.1. Model configuration

Included functions \ Model	TM-2657P-EX	TM-2657P-EG
Printer	○	○
Measurement status LED	○	○
Time,Date format	24hour,DD/month/YYYY	12hour,month/DD/YYYY

4.2. Performance specifications

General

AC Power supply	100-240V~ 50-60 Hz
Power consumption	50-80 VA
Safety standard	IEC60601-1:2005
MDD Classification	Class IIa (continuous operation mode)
EMC compliance	Complies with EMC standard IEC60601-1-2:2007.
Type of protection	NIBP: type B ⤴ Applied part
Type of protection against electrical shock	Class I

Blood pressure measurement

Measurement method	Oscillometric measurement
Pressure display range	0-299 mmHg
Pressure display accuracy	Pressure: ± 3 mmHg
NIBP Measurement range	SYS 40-270 mmHg DIA 20-200 mmHg Pulse rate 30-240 bpm
NIBP Clinical test	EN1060-4 :2004
Pulse rate accuracy	$\pm 5\%$
Cuff	Winding mechanism operated by geared motor
Applicable arm circumference	18-35 cm
Inflation	Automatic inflation by air pump
Deflation	Automatic deflation by mechanical exhaust
Rapid deflation	Automatic rapid deflation by solenoid valve

Environment specifications

Operating environment	Temperature: 10-40 °C Humidity: 15-85% RH (no condensation)
Storage environment	Temperature: -20 to 60 °C Humidity: 10-95% RH (no condensation)
Atmospheric pressure range	70-106 kPa (both for operation and storage)

Physical specifications

External dimensions	241 (W) x 324 (H) x 390 (D) mm
Weight	Approx. 5.5 kg

Functional specifications

Display method	3-digit display LED & LED lamp
Printer	Thermal printing, paper width: 58 mm
Usable life	5 years from installation According to A&D data (tested for use under recommended environment, including maintenance inspection. Results may be different under other conditions.)

4.3. External dimensions

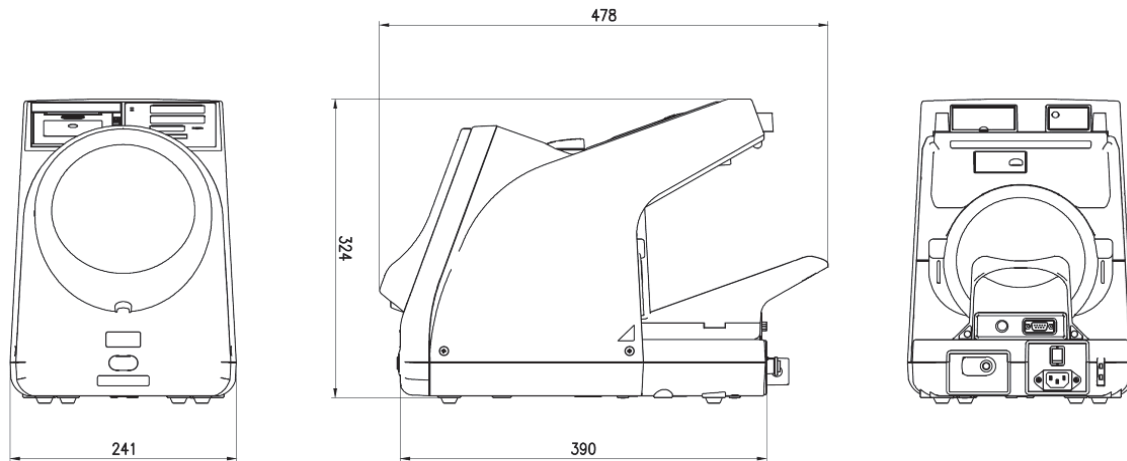

Unit:mm

4.4. Operation principles

The cuff pressure is raised to approximately 30 mmHg higher than the anticipated systolic pressure and then gradually depressurized. Pulsations occur in the cuff pressure that matches the heart rate. These pulsations have an undulating pattern. They start small and then gradually increase with depressurization. After the maximum amplitude (MAP) is reached, they decrease. An oscillometric blood pressure monitor analyzes the amplitude waveform data of these pulsations to determine the systolic and diastolic blood pressures.

4.5. Standards

The TM-2657P Automatic Blood Pressure Monitor complies with the following standards:

IEC 60601-1:2005 (Medical electrical equipment – Part 1: General requirements for safety and essential performance);

IEC 60601-1-2:2007 (Medical electrical equipment – Part 1-2: General requirements for basic safety and essential performance - Collateral Standard: Electromagnetic compatibility - Requirements and tests);

EN ISO810601-1:2012(Non-invasive sphygmomanometers - Part 1: Requirements and test methods for non-automated measurement type)

EN 1060-3: 1997 + A2: 2009 (Non-invasive sphygmomanometers - Part 3: Supplementary requirements for electro-mechanical blood pressure measuring systems);

EN 1060-4: 2004 (Non-invasive sphygmomanometers - Part 4: Test procedures to determine the overall system accuracy of automated non-invasive sphygmomanometers)

IEC 80601-2-30: 2009 (Medical electrical equipment –Part 2-30: Particular requirements for the basic safety and essential performance of automated non-invasive sphygmomanometers).

The TM-2657P is not made with natural rubber latex.

5. PART NAMES

Front

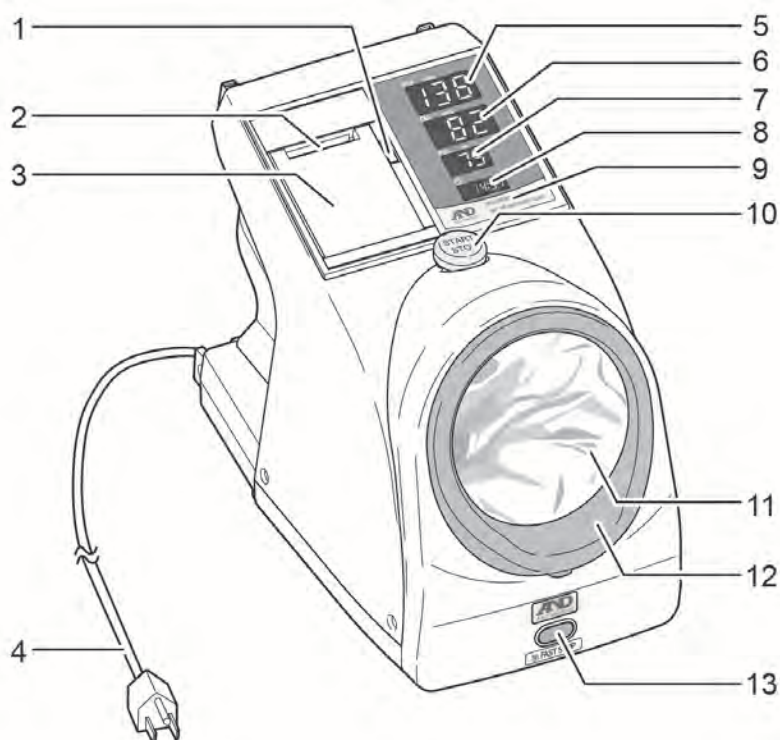

No.	Name	Description
1	Open printer cover button	Opens the printer cover.
2	Printer paper opening	Opening for printer paper to eject.
3	Printer cover	Holds down the printer paper.
4	Power cable	AC power cable.
5	Systolic blood pressure display	Displays the systolic blood pressure measurement value. When a measurement error occurs, the error code is displayed.
6	Diastolic blood pressure display	Displays the diastolic blood pressure measurement value. Displays the pressure during measurement.
7	Pulse display	Displays the pulse measurement value.
8	Clock display	Displays the current time. (24hour :TM-2657P-EX, 12hour :TM-2657P-EG)
9	Measurement status LED	Displays the measurement status. “MEASUREMENT IN PROGRESS” “TAKE MEASUREMENT AGAIN”
10	START/STOP button	If this button is pressed in the standby mode, blood pressure measurement is started. If this button is pressed during blood pressure measurement, blood pressure measurement is stopped.
11	Arm cuff cover	Inner cover of the cuff.
12	Cuff section	Holds the arm cuff cover.
13	FAST STOP button	If this button is pressed, the power is switched off and measurement is stopped.

Rear

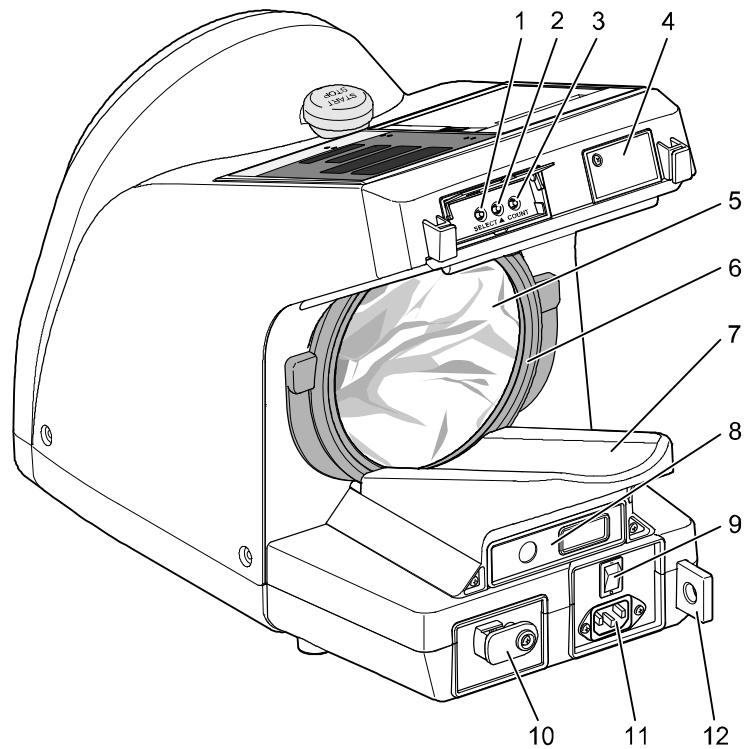

No.	Name	Description
1	SELECT button	Used to change functions.
2	▲ button	If pressed when the number of measurements to date is displayed, the number of measurements is printed. Used to change functions.
3	COUNT button	Displays the number of measurements to date. (See “12.5. Checking the number of measurements”)
4	Bitmap SD socket cover	Use for only maintenance.
5	Arm cuff cover	Inner cover of the cuff.
6	Cuff section	Holds the arm cuff cover.
7	Armrest	Location to rest the arm during measurement.
8	External input/output unit	The optional external input/output unit.
9	POWER switch	Switches the power on and off. Once the power is switched on, the monitor will be in the standby mode.
10	Cover for pressure inspection area	Used to check pressure accuracy.
11	AC INPUT connector	Location to insert the power cable.
12	Security slot	Can be used with a security cable to secure the monitor to a desk or pole. (For theft prevention)

External input/output unit (option)

- TM-2657-01 External input/output unit RS 2ch (option)

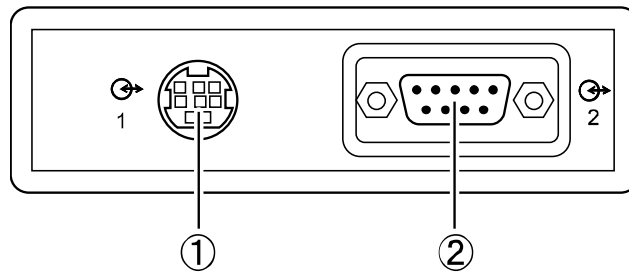

No.	Name	Description
1	Mini-DIN 8 pin female	RS-232C
2	D-Sub 9 pin male	RS-232C

- TM-2657-03 External input/output unit RS 1ch (option)

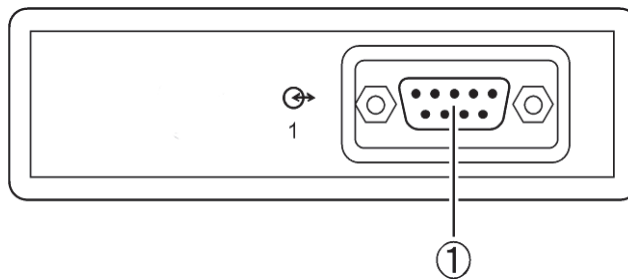

No.	Name	Description
1	D-Sub 9 pin male	RS-232C

- TM-2657-05 External input/output unit RS+Bluetooth (option)

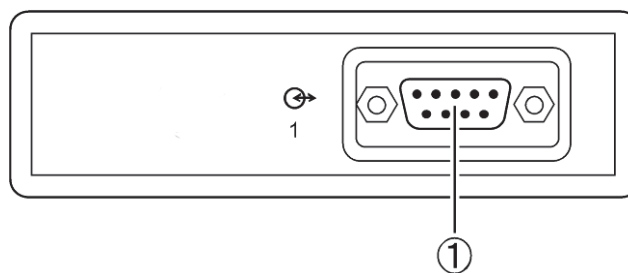

No.	Name	Description
—	Bluetooth	Bluetooth Ver.2.1 class1 SPP HDP correspondence
1	D-Sub 9 pin male	RS-232C

NOTE

- For details on EXTERNAL INPUT/OUTPUT UNIT (TM-2657-01, TM-2657-03, TM-2657-05), contact your local A&D dealer.

6. BEFORE USE

See the precautions at the beginning of this manual and install the monitor in an appropriate location using a safe and correct method.

6.1. Monitor installation

Attaching the armrest

Place the monitor on a stand so that measurement can be performed in an appropriate posture. The patient's heart and the cuff should be at the same height and the patient should be relaxed.

While referring to the illustration below, attach the armrest to the rear side of the monitor.

To prevent theft, we recommend using a chain to connect the security slot and stand. (See "6.3. Security slot")

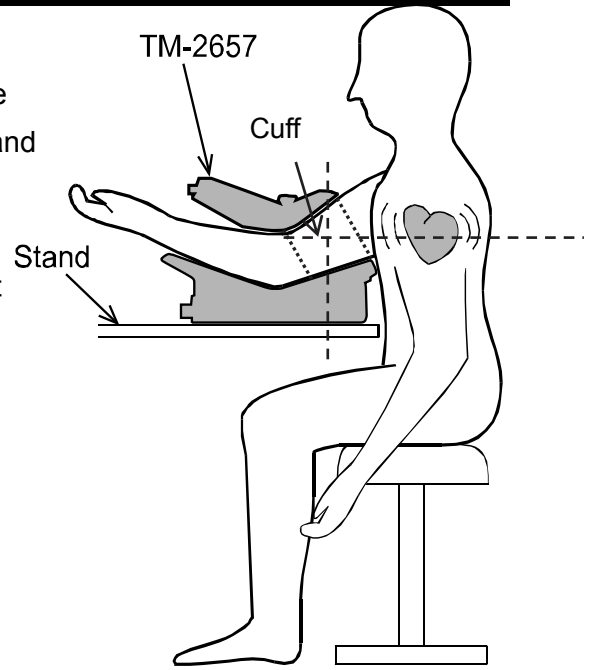

6.2. Power connection

Warning



- To avoid the risk of electric shock, the monitor must only be connected to a supply mains with protective earth.

Use the 3-pole power cable provided with the monitor to connect between the AC INPUT connector and an electrical outlet.

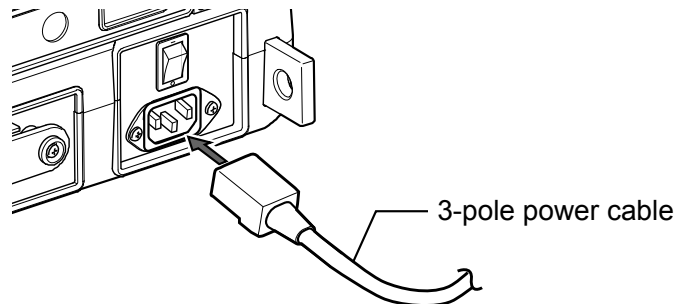

6.3. Security slot

The monitor can be secured to a table or pole by passing a security cable through the hole of the protruding tab on the monitor to secure it.

6.4. Attaching the instruction panel

See the illustration below to attach the instruction panel to the rear side of the monitor.

Caution



- Make sure to attach the instruction panel to the main unit before use. The instruction panel contains precautions that the patient must observe to use the monitor safely and correctly.

Instruction panel

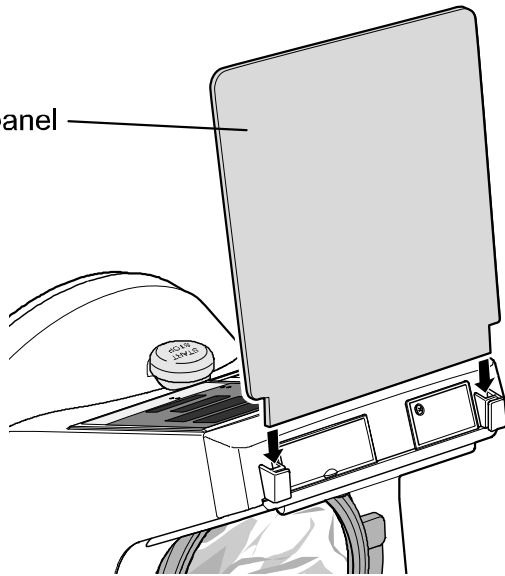

Monitor with the instruction panel attached

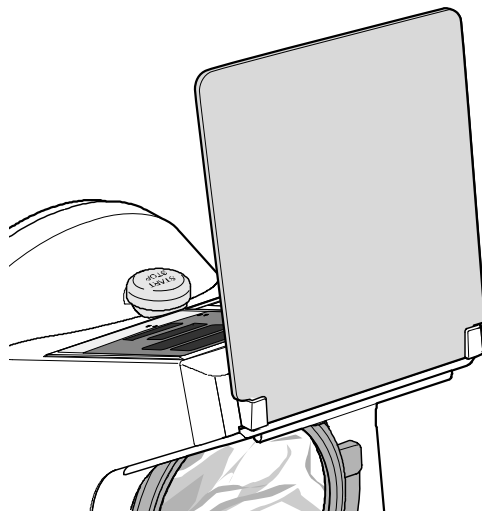

6.5. Pre-inspection

Warning



- Perform the pre-inspection every day to ensure safe and correct usage.

6.5.1. Introduction

Before using the monitor for the first time each day, perform the following pre-inspection.

6.5.2. Before switching the power on

- Is there any external deformation or damage to the monitor?
- Is the monitor wet?
- Is the monitor in a stable location free of tilting, vibrations and impacts?

Blood pressure measurement section

- Is there damage or abnormalities around the arm insertion section (cuff area)?
- Is the arm cuff cover attached?
- Is the arm cuff cover overstretched?

Connection cable

- Are the optional cables inserted firmly into the connectors of the monitor?

Power cable

- Make sure that the electrical outlet is properly grounded and supplies the specified voltage and frequency (100-240V~ 50-60 Hz).

6.5.3. After switching the power on

- Is there any smoke or strange smell?
- Can you hear any strange noises?

Checking the time

- Is the time set correctly?

If the time is incorrect when recording data, the data will be incorrect.

Checking the display

- After switching the power on, all LEDs switch on for several seconds and then blood pressure measurement is possible. At this time, the diastolic blood pressure display displays "0".

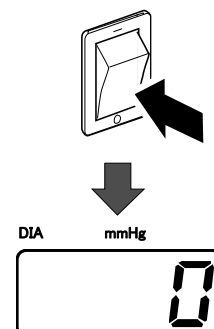

7. BLOOD PRESSURE MEASUREMENT

Warning



- To stop blood pressure measurement halfway through, press the **START/STOP** button. The cuff rapidly deflates and returns to its original state.
- If measurement cannot be stopped by pressing the **START/STOP** button, press the **FAST STOP** button (on the front of the monitor).

1. Insert bare arm or arm with a thin shirt into the arm insertion section up to the top of the shoulder. (If thick clothing is worn, the measurement results will be incorrect. Remove thick clothing before measurement.)

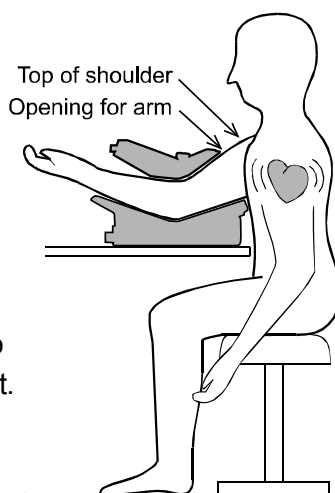

2. Press the **START/STOP** button to start blood pressure measurement.

3. The cuff automatically inflates. Keep the arm still in the cuff during the measurement.

4. After inflation, deflation starts automatically. As the pressure decreases, measurement is performed. The patient must relax and remain still. (See “10.3. Applied pressure”)

5. After about one minute of measurement, the cuff automatically deflates to its original state.

6. The measurement results are displayed.

7. The measurement results are printed on the printer paper. Remove the arm from the cuff. (See “10.5. Print quality”)

START/STOP button



DIA mmHg
146

Applying pressure

DIA mmHg
103

Releasing pressure during measurement

Result

SYS mmHg
138

DIA mmHg
74

PUL /min.
76

Printout

Note

- When performing continuous measurements, wait 2 to 3 minutes between measurements for the patient to relax.
- Blood pressure measurement results are affected by the posture and physical condition of the patient.
- If the patient moves or talks during measurement, correct measurement is not possible.
- To obtain accurate measurement results, ensure the patient sits with good posture and his/her back straight, and with his/her feet flat on the floor without crossing legs. Ensure the patient is relaxed and remains still.
- Adjust the height of the chair such that the cuff is at the same height as the heart. If the cuff is not at the same height as the heart, correct measurement is not possible.

8. SETTING THE CLOCK

To set the date and time, use clock setting mode. Clock setting mode has the following display.

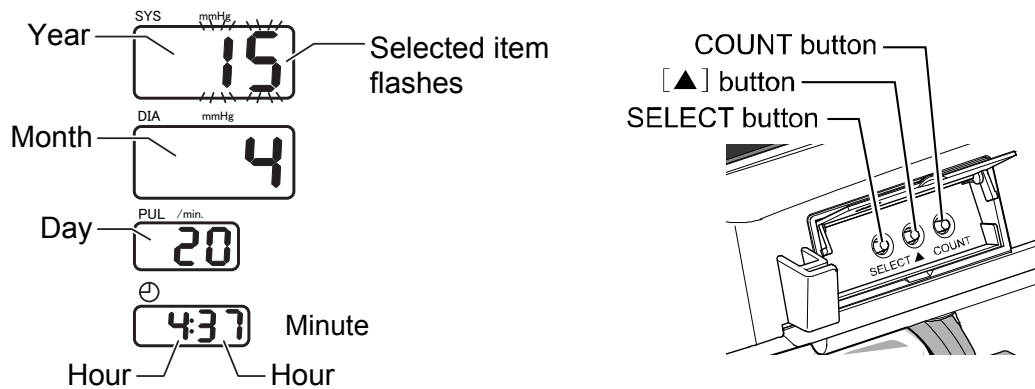

Setting the date and time:

Use the following buttons.

- SELECT** button: 1. While the monitor is in standby mode, hold the **SELECT** button for 1 second to enter clock setting mode. The year value will start flashing.
2. Press the **SELECT** button to select the date or time value to be set. Each time the **SELECT** button is pressed, the flashing value changes from year, month, day, hour, minute, and then back to year. The selected item flashes and can be changed.
- ▲** button: Change the selected (flashing) values.
- START/STOP** button: Once the desired date and time is selected, press the **START/STOP** button to save the changes and return to standby mode.
- COUNT** button: If the **COUNT** button is pressed while configuring settings, changes are not saved and the monitor returns to standby mode.

Example: Setting the clock to 4:37 PM, April 20, 2015

1. Hold the **SELECT** button for 1 second. The systolic display section starts flashing.
2. Press the **▲** button to display 15. (2015)
3. Press the **SELECT** button. The diastolic display section starts flashing.
4. Press the **▲** button to display 4. (April)
5. Press the **SELECT** button. The pulse display section starts flashing.
6. Press the **▲** button to display 20. (20th)
7. Press the **SELECT** button to select the hour on the clock display. The hour setting starts flashing.
8. Press the **▲** button to display 4. (4 PM)
9. Press the **SELECT** button to select the minute on the clock display. The minute setting starts flashing.
10. Press the **▲** button to display 37. (37 minutes)
11. Press the **START/STOP** button to return to standby mode.

Notes

- If no operation is performed for about 10 seconds, the specified settings are set. After **Red** is displayed for 2 seconds, the monitor returns to the standby mode.
- Dates up to December 31, 2050 are supported.

9. PRINTER

9.1. Installing the printer paper

 **Caution**



- Do not pull the printer paper during printing. It may damage the printer head.

1. Press the **Open printer cover** button to open the printer cover.

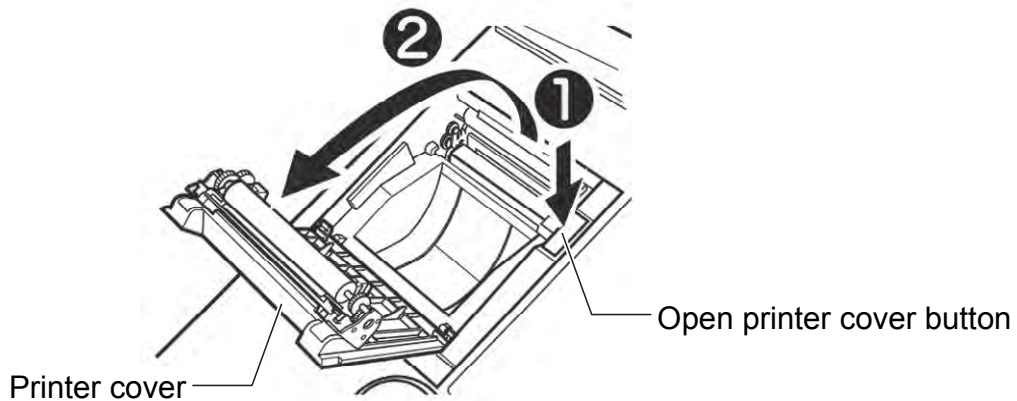

2. Install the printer paper in the way shown in the illustration below.

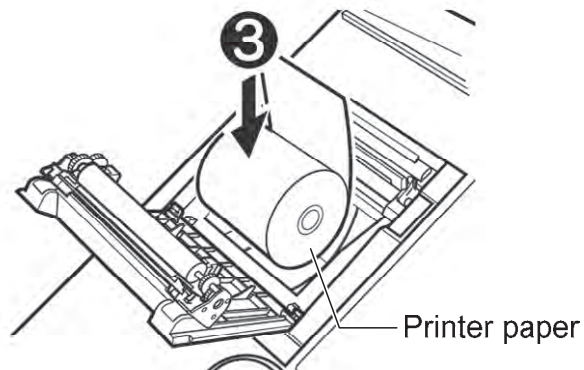

3. With the end of the paper at the top and protruding out, secure the printer paper by closing the printer cover until you hear a click. If the cover is not completely closed, a paper jam may occur.

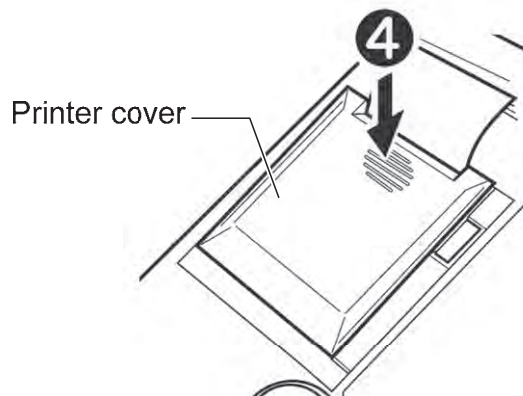

- If the high-speed printing mode is used, approximately 700 prints are possible from one printer paper roll. With 3-line printing mode, 600 prints are possible. When the end of the printer paper roll becomes pink, replace the paper.
- Use thermal paper only.
- If the following error codes are displayed in the systolic display section, a printer error has occurred.

Perform the required countermeasure.

Error code	Error/countermeasure
<i>PE</i>	No printer paper. Install a new printer paper roll.
<i>Po</i>	The printer cover is open. Firmly close the printer cover.
<i>Pc</i>	A printer cutter error. Open the printer cover, check the printer paper, and then close the printer cover.

- When no printer error is displayed and the monitor is in standby mode, holding down the ▲ button for 2 seconds will cut the paper.

Note
<ul style="list-style-type: none"> ■ If the direction of the printer paper is incorrect, printing is not performed. ■ Use genuine A&D printer paper. If genuine A&D paper is not used, the print may be too light or paper jams may occur. ■ On the last 60 cm of printer paper, there are pink end marks (pink lines on both sides). If these end marks appear, replace the printer paper. ■ Thermal printer paper is used. Note that discoloration or fading may occur. <ul style="list-style-type: none"> □ Items that will be discolored: Felt-tip pens and adhesive agents including starch and organic solvents. □ Items that can cause fading: Highlight pens, tape, transparent storage cases, desk pads, sunlight and ultraviolet. <p>Because of the abovementioned causes, make a copy of measurement results when saving them.</p> ■ With high speed and 3-line printing, approximately 700 and 600 prints are possible respectively (in the case of 30 m standard printer paper and measurement value printing only.)

9.2. Selecting the print format

By configuring settings in “10. CHANGING FUNCTIONS”, users can format the information on the printout. The printing area is divided into 4 sections: print header, measurement value, graph and bitmap. Each section has printing items available for selection.

For details, see “10. CHANGING FUNCTIONS”.

1. Print header

The values in the parentheses are the possible settings for each item.

a: ID and name printing (**F08**: oFF/1/2/3)

b: IHB (**F05**: on/off)

c: Title (fixed)

d: Measurement start date format (**F26**)

e: Measurement start time format (**F27**)

f : Height and weight values printing (**F16**)

Can be selected by
changing functions

2. Measurement value printing (**F11**)

The following modes are available for selection.

High-speed printing (**1**)

Normal 3-line printing (**2**)

Big font printing (**3**)

Table printing (**4**)

For each mode, mean arterial pressure (MAP) printing can be set to on or off. (**F09**)

3. Graph printing (**F12**)

The following items are available for selection.

Graph printing (off)

Pulse fluctuation graph printing (**1**)

4. Bitmap printing (**F15**)

The following items are available for selection.

Bitmap printing (off)

Standard pattern printing (**1**)

User pattern printing (**2**)

5. ICT printing (**F29**)

The following items are available for selection.

ICT printing (off)

Bar code printing **(1)**

QR code printing, including ID **(2)**

Bar code printing(CODE39, with check digit (modulus43)) **(3)**

QR code printing V2, including ID **(4)**

1. Print header F08 F05 F26 F27 F16
2. Measurement value printing F11 F09
3. Graph printing F12
4. Bitmap printing F15
5. ICT printingF29

Printing example 1: Initial settings

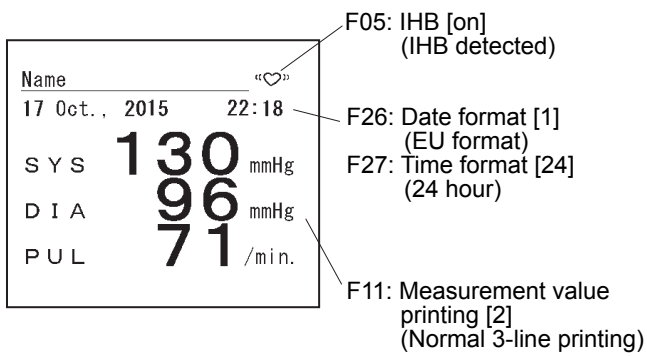

F05: IHB [on]
 (IHB detected)

F26: Date format [1]
 (EU format)

F27: Time format [24]
 (24 hour)

F11: Measurement value
 printing [2]
 (Normal 3-line printing)

Printing example 2:

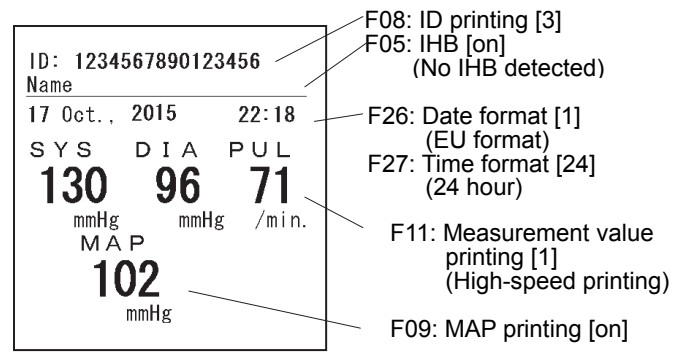

F08: ID printing [3]

F05: IHB [on]
 (No IHB detected)

F26: Date format [1]
 (EU format)

F27: Time format [24]
 (24 hour)

F11: Measurement value
 printing [1]
 (High-speed printing)

F09: MAP printing [on]

Printing example 3:

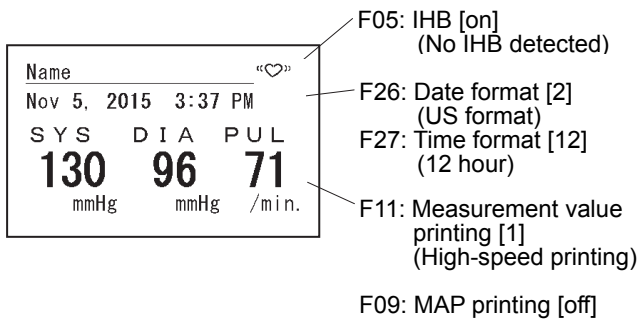

F05: IHB [on]
 (No IHB detected)

F26: Date format [2]
 (US format)

F27: Time format [12]
 (12 hour)

F11: Measurement value
 printing [1]
 (High-speed printing)

F09: MAP printing [off]

10. CHANGING FUNCTIONS

The multi-functional monitor can be configured for various applications by changing function settings.

To change function settings, use the buttons located on the rear panel of the monitor while the monitor is in standby mode.

10.1. Procedure to Change Function Settings

1. In power off mode, hold both the **▲** and **SELECT** buttons down and switch the power on.
F01 is displayed in the systolic display section and the monitor enters the function changing mode.
2. Each time the **SELECT** button is pressed, the setting item changes to **F02, F03...**
3. Each item can be changed using the **▲** button.
4. After completing the settings, switch the power off and then on again.

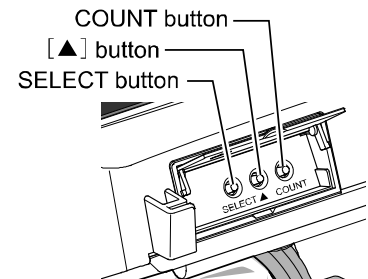

Setting items	Details	Default	Diastolic display section	Function
F01	Not used	—		
F02	Display time	20	OFF,5,10,20,999	Measurement result display time (seconds)
F03	Applied pressure	R _{ut}	R _{ut} ,160,180,200	Applied pressure setting (mmHg)
F04	Not used	—		
F05	IHB	on	OFF/on	IHB-mark printing on/off
F06	Not used	—		
F07	Print quality/ light or dark		OFF	Printing off
			1	Light printing (high speed)
		○	2	Standard printing
F08	ID and name printing		3	Dark high-quality printing (low speed)
		○	OFF	ID : No / Name : No
			1	ID : No / Name : Yes
F09	Mean arterial pressure (MAP) printing		2	ID : Yes / Name : No
		○	3	ID : Yes / Name : Yes
			OFF	Mean arterial blood pressure (MAP) printing on/off
F10	Not used	—		
F11	Measurement value printing		1	High-speed printing
		○	2	Normal 3-line printing
			3	Big font printing
			4	Table printing
F12	Graph printing	○	OFF	Graph printing off
			1	Pulse fluctuation graph printing
F13	Not used	—		
F14	Not used	—		
F15	Bitmap printing	○	OFF	Bitmap printing off
			1	Standard pattern printing
			2	User pattern printing

Setting items	Details	Default	Diastolic display section	Function
F16	Height and weight values printing		OFF	Height and weight values printing OFF
			1	Printer mode printing
		○	2	Integrated mode printing
F17	Not used	—		
F18	Beep sound	on	OFF/on	Beep sound on/off
F19	Not used	—		
F20	External input/output protocol		OFF	No connection
		○	1	Mini-DIN: Blood pressure result input/output (STD/RI/RB/BP/RA) D-Sub: Blood pressure result input/output (STD/RI/RB/BP/RA)
			2	Mini-DIN: A&D weight scale D-Sub: Blood pressure result input/output (STD/RI/RB/BP/RA)
			3	Mini-DIN: Blood pressure result input/output (STD/RI/RB/BP/RA) D-Sub: ID reader
			4	Mini-DIN: Blood pressure result input/output (STD/RI/RB/BP/RA) D-Sub: Ux compatibility
			5	Mini-DIN: Blood pressure result input/output (STD/RI/RB/BP/RA) D-Sub: RVX compatibility
			6	Mini-DIN: Blood pressure result input/output (STD/RI/RB/BP/RA) D-Sub: A&D weight scale
	7	Mini-DIN: Blood pressure result input/output (STD/RI/RB/BP/RA) D-Sub: RVY compatibility		
F21	Transmission speed (Mini-DIN)		120	1200 bps
		○	240	2400 bps
			480	4800 bps
			960	9600 bps
F22	Transmission speed (D-Sub)		120	1200 bps
		○	240	2400 bps
			480	4800 bps
			960	9600 bps
F23	Stop bit (Mini-DIN)	○	1	Stop bit: 1
			2	Stop bit: 2
F24	Stop bit (D-Sub)	○	1	Stop bit: 1
			2	Stop bit: 2
F25	Blood pressure result output	○	1	RB (no ID, immediately after measurement) + STD
			2	RI (with ID, immediately after measurement)+ STD
			3	BP (with ID, immediately after measurement)only
			4	STD (command response) only
	5	RA (with ID, immediately after measurement)		
F26	Date format	※	EU	DD month., YYYY
			US	month. DD, YYYY
F27	Time format	※	24	24 hour
			12	12 hour (AM/PM)
F28	Not used	—		

※F16 setting is valid only if F20 setting is 2 or 6.

※ The default setting depends on the destination.

Setting items	Details	Default	Diastolic display section	Function
F29	ICT printing	<input type="radio"/>	OFF	ICT printing OFF
			1	Bar code printing (CODE39)
			2	QR code printing, including ID
			3	Bar code printing (CODE39 , with check digit (modulus43))
			4	QR code printing V2, including ID
F31	Bluetooth connection timing	<input type="radio"/>	1	Connection at the end of measurement
			2	Connection at the start of measurement

To reset all settings to factory default settings, hold the **START/STOP** button for 5 seconds when any of the “**FXX**” numbers are displayed.

10.2. Display time

The display time for measurement results can be set using the function **F02**.

Use the ▲ button to change the setting. This setting appears in the diastolic display section.

DIA LED	Display time setting	Default
<i>off</i>	No display of results (All values are displayed as “---”)	<i>20</i>
<i>5</i>	5 seconds	
<i>10</i>	10 seconds	
<i>20</i>	20 seconds	
<i>999</i>	Remains displayed	

10.3. Applied pressure

The applied pressure can be set using the function **F03**.

Use the ▲ button to change the setting. This setting appears in the diastolic display section. (If automatic applied pressure (**Aut**) is set, pulsation is observed while pressure is applied and the applied pressure value is automatically determined.)

DIA LED	Applied pressure setting	Default
<i>Aut</i>	Automatic applied pressure	<i>Aut</i>
<i>160</i>	160 mmHg	
<i>180</i>	180 mmHg	
<i>200</i>	200 mmHg	

10.4. IHB

The IHB setting can be set using the function **F05**.

Use the ▲ button to change the setting. This setting appears in the diastolic display section.

DIA LED	IHB setting	Default
<i>off</i>	IHB off	<i>on</i>
<i>on</i>	IHB on	

When IHB is on:

Printing example

When IHB is detected

Name	“♥”	IHB
17 Oct., 2015	22:18	

When IHB is not detected

Name	
17 Oct., 2015	22:18

For details on IHB, see “3. ABBREVIATIONS AND SYMBOLS”.

10.5. Print quality

The print quality can be set using the function **F07**.

Use the ▲ button to change the setting. This setting appears in the diastolic display section.

DIA LED	Print quality setting	Default
<i>OFF</i>	Printing off	2
1	Light printing (high speed)	
2	Standard printing	
3	Dark high-quality printing (low speed)	

10.6. ID and name printing

ID printing can be set using the function **F08**.

Use the ▲ button to change the setting. This setting appears in the diastolic display section.

(Only TM-2657VP, TM-2657P)

DIA LED	ID printing setting	Default
<i>OFF</i>	ID : No / Name : No	!
1	ID : No / Name : Yes	
2	ID : Yes / Name : No	
3	ID : Yes / Name : Yes	

When ID and name printing is on:

Printing example

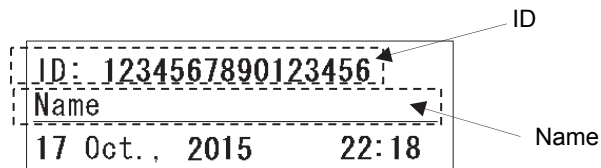

To input an ID, set the function **F20** to **3**, and connect an ID reader.

The ID data is maintained until the blood pressure is measured correctly and is cleared immediately after the result is displayed or printed.

10.7. Mean arterial pressure (MAP) printing

Mean arterial pressure (MAP) printing can be set using the function **F09**.

Use the **▲** button to change the setting. This setting appears in the diastolic display section.

DIA LED	Mean arterial pressure printing	Default
<i>OFF</i>	Mean arterial pressure (MAP) printing off	<i>OFF</i>
<i>ON</i>	Mean arterial pressure (MAP) printing on	

When mean arterial pressure (MAP) printing is on:

Printing example

High speed printing

Name
17 Oct., 2015 22:18
SYS DIA PUL
130 96 71
mmHg mmHg /min.
MAP
102
mmHg

Mean arterial pressure (MAP)

Big font printing

Name
17 Oct., 2015 22:18
SYS
130 mmHg
MAP
102 mmHg
DIA
96 mmHg
PUL
71 /min.

Mean arterial pressure (MAP)

Normal printing

Name
17 Oct., 2015 22:18
SYS 130 mmHg
MAP 102 mmHg
DIA 96 mmHg
PUL 71 /min.

Mean arterial pressure (MAP)

10.8.Measurement value printing

Measurement value printing can be set using the function **F11**.

Use the ▲ button to change the setting. This setting appears in the diastolic display section.

DIA LED	Measurement value printing mode	Default
1	High-speed printing	2
2	Normal 3-line printing	
3	Big font printing	
4	Table printing	

When Mean arterial pressure (MAP) printing is off:

Printing example

High-speed printing

Name	
Oct. 17, 2015	22:18
SYS	DIA PUL
130	96 71
mmHg	mmHg /min.

Big font printing

Name	
17 Oct., 2015	22:18
SYS	
130	mmHg
DIA	
96	mmHg
PUL	
71	/min.

Normal 3-line printing

Name		«♥»
17 Oct., 2015	22:18	
SYS	130	mmHg
DIA	96	mmHg
PUL	71	/min.

Table printing

17 Oct., 2015		22:18	
[mmHg] [/min.]			
No.	TIME	SYS	DIA PUL
00001	10:18	124	86 72
00002	10:26	101	78 62
00003	11:28	148	92 86
00004	11:30	152	102 78

When IHB (**F05**) is on and IHB is detected

Note

- In the table printing mode, paper is not cut automatically. To cut paper, hold the ▲ button for 2 seconds while the monitor is in the standby mode.

10.9. Graph printing

The graph printing settings can be set using the function **F12**.

Use the ▲ button to change the setting. This setting appears in the diastolic display section.

DIA LED	Graph printing	Default
OFF	Graph printing off	OFF
1	Pulse fluctuation graph printing	

Printing example: Pulse fluctuation graph printing

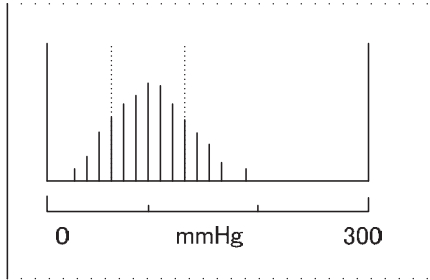

10.10. Bitmap printing

Bitmap printing can be set using the function **F15**.

Use the ▲ button to change the setting. This setting appears in the diastolic display section.

DIA LED	Bitmap printing	Default
OFF	Bitmap printing off	OFF
1	Standard pattern printing	
2	User pattern printing	

For details about bitmap registration, see “15. SENDING BITMAP PATTERNS”.

For details on user pattern printing, see “15. SENDING BITMAP PATTERNS”.

Bitmaps up to 384 x 640 pixels can be printed.

Printing example: Standard pattern printing

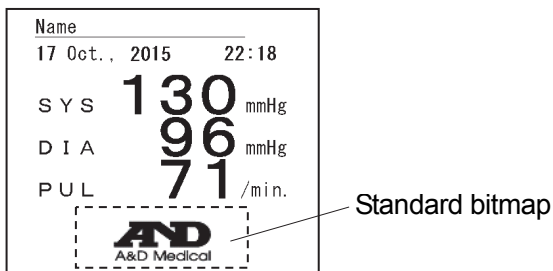

10.11. Beep sound

The key operation sound when a measurement starts/ends can be set to ON/OFF using the function **F18**.

Use the ▲ button to change the setting. This setting appears in the diastolic display section.















DIA LED	Buzzer	Default
OFF	Beep sound off	ON
ON	Beep sound on	

10.12. External input/output protocol







The protocol settings for connections can be set using the function **F20**.

Use the **▲** button to change the setting. This setting appears in the diastolic display section.







External input/output unit < TM-2657-01 >

DIA LED	External input/output unit (option) protocol	Default
OFF	No connection	
1	Mini-DIN:  Blood pressure result input/output (STD/RI/RB/BP/RA) D-Sub:  Blood pressure result output (STD/RI/RB/BP/RA)	
2	Mini-DIN:  A&D height and weight scale D-Sub:  Blood pressure result input/output (STD/RI/RB/BP/RA)	
3	Mini-DIN:  Blood pressure result input/output (STD/RI/RB/BP/RA) D-Sub:  ID reader	
4	Mini-DIN:  Blood pressure result input/output (STD/RI/RB/BP/RA) D-Sub:  Ux compatibility	!
5	Mini-DIN:  Blood pressure result input/output (STD/RI/RB/BP/RA) D-Sub:  RVX compatibility	
6	Mini-DIN:  Blood pressure result input/output (STD/RI/RB/BP/RA) D-Sub:  A&D weight scale	
7	Mini-DIN:  Blood pressure result input/output (STD/RI/RB/BP/RA) D-Sub:  RVY compatibility	

External input/output unit < TM-2657-03 >

DIA LED	External input/output unit (option) protocol	Default
OFF	No connection	
1	D-Sub:  Blood pressure result input/output (STD/RI/RB/BP/RA)	
2	D-Sub:  Blood pressure result input/output (STD/RI/RB/BP/RA)	
3	D-Sub:  ID reader	
4	D-Sub:  Ux compatibility	!
5	D-Sub:  RVX compatibility	
6	D-Sub:  A&D height and weight scale	
7	D-Sub:  RVY compatibility	

External input/output unit < TM-2657-05 >

DIA LED	External input/output unit (option) protocol	Default
OFF	No connection	
1	D-Sub :  Blood pressure result input/output (STD/RI/RB/BP/RA)	
2	D-Sub :  Blood pressure result input/output (STD/RI/RB/BP/RA)	
3	D-Sub :  ID reader	
4	D-Sub :  Ux compatibility	!
5	D-Sub :  RVX compatibility	
6	D-Sub :  A&D height and weight scale	
7	D-Sub :  RVY compatibility	

For details on communication commands (STD/RI/RB/BP/RA), contact your local A&D dealer.

For details on connecting ID readers, weight scales, or computers, contact your local A&D dealer.

10.13. Transmission speed (Mini-DIN)

The Mini-DIN  transmission speed can be set using the function **F21**.

Use the **▲** button to change the setting. This setting appears in the diastolic display section.

DIA LED	Transmission speed (Mini-DIN)	Default
120	1200 bps	240
240	2400 bps	
480	4800 bps	
960	9600 bps	

10.14. Transmission speed (D-Sub)

The D-Sub  transmission speed can be set using the function **F22**.

Use the **▲** button to change the setting. This setting appears in the diastolic display section.

DIA LED	Transmission speed (D-Sub)	Default
120	1200 bps	240
240	2400 bps	
480	4800 bps	
960	9600 bps	

10.15. Stop bit (Mini-DIN)

The stop bit (Mini-DIN ) can be set using the function **F23**.

Use the **▲** button to change the setting. This setting appears in the diastolic display section.

DIA LED	Stop bit (Mini-DIN)	Default
1	Stop bit 1	1
2	Stop bit 2	

10.16. Stop bit (D-Sub)

The stop bit (D-Sub ) can be set using the function **F24**.

Use the **▲** button to change the setting. This setting appears in the diastolic display section.

DIA LED	Stop bit (D-Sub)	Default
1	Stop bit 1	1
2	Stop bit 2	

10.17. Blood pressure result output

The blood pressure result output can be set using the function **F25**.

Use the **▲** button to change the setting. This setting appears in the diastolic display section.

DIA LED	Blood pressure result output	Default
1	RB (no ID, immediately after measurement) + STD	1
2	RI (with ID, immediately after measurement) + STD	
3	BP (with ID, immediately after measurement) only	
4	STD (command response) only	
5	RA (with ID, immediately after measurement)	

For details on transmission printing, contact the local A&D dealer.

10.18. Date format

The printing date format can be set using the function **F26**.

Use the **▲** button to change the setting. This setting appears in the diastolic display section.

DIA LED	Date format	Default
<i>F11</i>	DD month., YYYY	※
<i>U5</i>	month DD, YYYY	

※ The default setting depends on the destination.

10.19. Time format

The time format can be set using the function **F27**.

Use the **▲** button to change the setting. This setting appears in the diastolic display section.

DIA LED	Time format	Default
<i>24</i>	24 hour	※
<i>12</i>	12 hour (AM/PM)	

※ The default setting depends on the destination.

10.20. ICT printing

The ICT printing can be set using the function **F29**. Use the **▲** button to change the setting. This setting appears in the diastolic display section.

DIA LED	ICT printing	Default
<i>OFF</i>	ICT printing OFF	<i>OFF</i>
<i>1</i>	Bar code printing (CODE39)	
<i>2</i>	QR code printing, including ID	
<i>3</i>	Bar code printing (CODE39 , with check digit (modulus43))	
<i>4</i>	QR code printing V2, including ID	

※The following information is included in code printing.

- Bar code printing : Systolic blood pressure value, mean blood pressure value, diastolic blood pressure value, pulse rate
- QR code printing : YYYY/MM/DD/HH/MM, ID (16 digits), systolic blood pressure value, mean blood pressure value, diastolic blood pressure value, pulse rate
- Bar code printing (CODE39 , with check digit (modulus43)) : Systolic blood pressure value, diastolic blood pressure value, pulse rate
- QR code printing V2 : YYYY/MM/DD/HH/MM, ID(16digits), systolic blood pressure value, mean blood pressure value, diastolic blood pressure value, pulse rate, height value, weight value

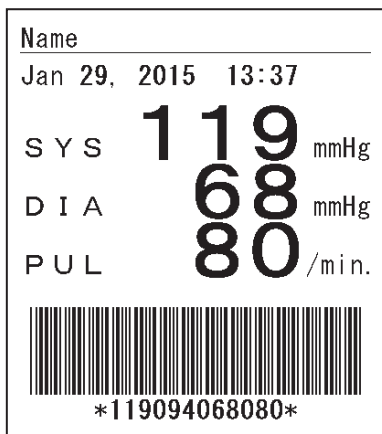

Printing example)
Bar code printing (CODE39)



Printing example)
QR code printing, including ID

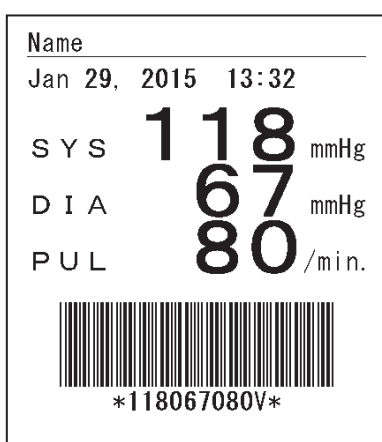

Printing example)
Bar code printing
(CODE39 , with check digit (modulus43))

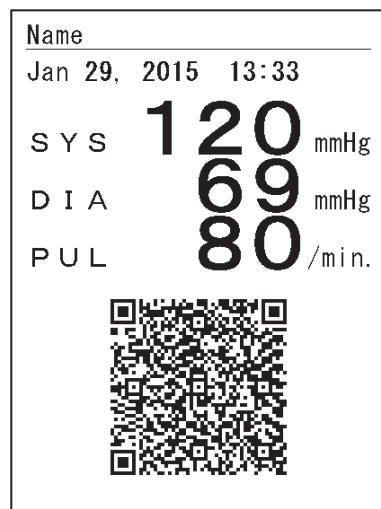

Printing example)
QR code printing V2, including ID

- ※ For details on ICT printing, contact your local A&D dealer.
- ※ QR code is a registered trademark of DENSO WAVE Incorporated.

10.21. Bluetooth connection timing

The Bluetooth connection timing can be set using the function **F31**. Use the **▲** button to change the setting. This setting appears in the diastolic display section.

DIA LED	ICT printing	Default
1	Connect at the end of measurement	1
2	Connect at the start of measurement	

< Connect at the end of measurement >



Connect with the host device after each measurement and start Bluetooth transmission.

< Connect at the start of measurement >

Connect with the host device at the start of each measurement and start Bluetooth transmission.

11. TRANSMISSION SPECIFICATIONS

The monitor can connect to the optional external input/output unit. Various settings for each channel are available from functions **F20** to **F25**.

 Caution	
	<ul style="list-style-type: none">■ The personal computer and medical equipment connected to the device must be located out of reach of the patient.■ The personal computer or ID reader used must conform to EN60601-1

11.1. External input/output unit

unit	function
TM-2657-01	Mini-DIN 8pin female, D-Sub 9pin male
TM-2657-03	D-Sub 9pin male
TM-2657-05	Bluetooth, D-Sub 9pin male

NOTE
<ul style="list-style-type: none">■ For details on EXTERNAL INPUT/OUTPUT UNIT (TM-2657-01、TM-2657-03、TM-2657-05), contact your local A&D dealer.

11.1.1. Mini-DIN 8 pin female (External input/output unit : only TM-2657-01)

Transmission specifications

Main standard	Complies with EIA RS-232C
Transmission format	Stop-start system (Full duplex)
Signal speed	1200, 2400, 4800 and 9600 bps (can be changed using F21)
Transmission format	Can be changed using F20
Data bit length	8 bits, 7 bits
Parity	None
Stop bit	1 bit, 2 bits (can be changed using F23)
Code	ASCII

Pin assignment

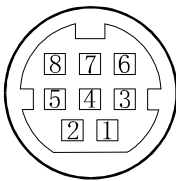

Pin No.	Signal name	Description
1	TXD	Transmit data
2	RXD	Receive data
3	RTS	Request to send
4	—	No connection
5	CTS	Clear to send
6	GND	Signal ground
7	—	No connection
8	—	No connection

※Do not connect to Pins No. 4, 7, or 8. They are used for the blood pressure monitor.

Cable specifications for computer connection

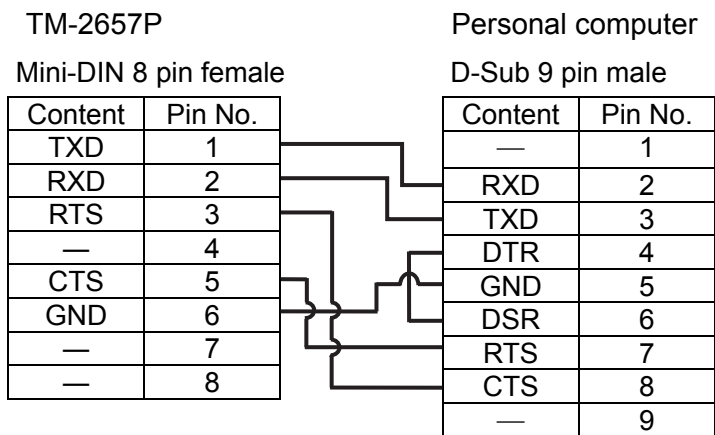

11.1.2. D-Sub 9-pin male (External input/output unit : All units common)

Transmission specifications

Output standards	Complies with EIA RS-232C
Transmission format	Stop-start system (Full duplex)
Signal speed	1200, 2400, 4800 and 9600 bps (can be changed using F22)
Transmission format	Can be changed using F20
Data bit length	8 bits
Parity	None
Stop bit	1 bit, 2 bits (can be changed using F24)
Code	ASCII

Pin assignment

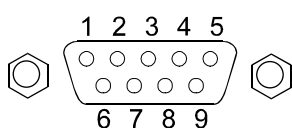

Pin No.	Signal name	Description
1	—	—
2	RXD	Receive data
3	TXD	Transmit data
4	DTR	Data terminal ready
5	GND	Signal ground
6	DSR	Data set ready
7	RTS	Request to send
8	CTS	Clear to send
9	—	—

※The protocol depends on the equipment connected.

Cable connection between the device and a personal computer

TM-2657P
D-Sub 9 pin male
D-sub connector



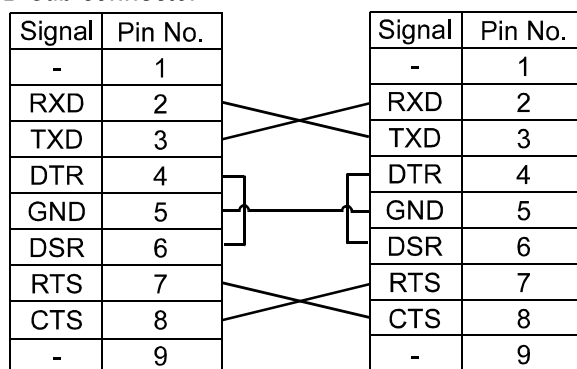

Personal computer or ID Reader
D-Sub 9 pin male
D-sub connector





11.1.3. Bluetooth (External input/output unit : only TM-2657-05)

In order to use the Bluetooth transmission function of the TM-2657 series safely and correctly, carefully read the following precautions before using the monitor. The following content summarizes general matters regarding the safety of patients and operators, in addition to the safe handling of the monitor.

Before using the monitor

 Warning	
	<ul style="list-style-type: none">■ Do not use in places where wireless communication is prohibited, such as on airplanes or in hospitals. This monitor may have an adverse effect on electronic devices or medical electrical equipment.
	<ul style="list-style-type: none">■ If implantable heart pacemaker or implantable cardioverter defibrillator are used, please contact about the influence of radio waves individually to medical electrical equipment manufacture.■ For such as warning and caution about the handling of sphygmomanometer body, please follow the description of the instruction manual of sphygmomanometer.
 Caution	
	<ul style="list-style-type: none">■ This monitor has built-in wireless equipment with construction design certification as wireless equipment of a low electric power data communicating system based on regulations of the Radio Act. Therefore, when the wireless function of this equipment is used, wireless station permission is not necessary.■ Disassembly or modification of this monitor may be punished by a law because this monitor has construction design certification.

During use of the wireless equipment

 Caution	
	<ul style="list-style-type: none">■ We cannot accept any responsibility for any losses incurred such as operating malfunctions or loss of data that may occur through the use of this monitor.■ This monitor is not guaranteed to connect with all Bluetooth compatible devices.■ In the event of radio wave interference from the monitor to the other wireless station, change the location of use or stop using immediately.

 **Warning**



- Do not use in the vicinity of cell phones. This could cause malfunction.



NOTE

- Ensure wireless device is within view of the monitor. Wireless range is affected by building structure and obstructions. Specifically, reinforced concrete can cause wireless interference.
- For the Bluetooth connection, do not use the monitor around wireless LAN, other wireless applications and the devices that radiate electromagnetic waves such as microwave ovens, or in location with many obstructions or other environment subject to weaker radio wave signals.

There is a possibility that the wireless connection may break up frequently, the communication speed may fall to an extremely low level, or a communication error occurs.

- If the monitor is used near a wireless IEEE802.11g/b/n LAN device, both devices may generate a radio interference which could decrease wireless speed or break the wireless connection. In this case, change the location of use or stop using immediately.
- If the monitor cannot normally transmit data near a radio or broadcast station, please change the location.

1) Transmission specifications

Main standard	Bluetooth Ver.2.1 class1	
Supported profiles	SPP,HDP	
Devices that can be connected	<ul style="list-style-type: none"> ● Continua certified devices ● iPhone、 iPad、 iPod ● Applications and devices that are compatible with SSP and A&D specifications <p>However, each device needs an application to receive data. For connection methods, refer to the manual for each device.</p> <div style="display: flex; justify-content: space-between; align-items: flex-start;"> <div style="text-align: center;">  <p>Bluetooth[®]</p> </div> <div style="text-align: left;"> <p>Bluetooth devices described the Bluetooth logo mark.</p> </div> </div> <div style="display: flex; justify-content: space-between; align-items: flex-start; margin-top: 10px;"> <div style="text-align: center;">  <p>Continua[™] CERTIFIED</p> </div> <div style="text-align: left;"> <p>Continua certified devices described with the Continua logo mark.</p> </div> </div> <div style="display: flex; justify-content: space-between; align-items: flex-start; margin-top: 10px;"> <div style="text-align: center;">  </div> <div style="text-align: left;"> <p>iPhone, iPad and iPod are trademarks of Apple Inc., registered in the U.S. and other countries.</p> </div> </div>	

2) Pairing

A Bluetooth device needs to be paired with a different specific device in order to communicate with that device. When this monitor is paired with a receiver device, measurement data is transmitted automatically to the receiver device each time a measurement is made

Follow the steps below to pair the monitor with a Bluetooth compatible receiver device. Also refer to pairing in the manual of the receiver device. Please use a pairing wizard if it provided.

- ① Follow the instructions in the manual of the receiver device to switch it to the state that a pairing is possible. When pairing this monitor, place it as close as possible to the receiver device to be paired with.
- ② Hold down the **SELECT** button and turn on the power.
Press the **START/STOP** button after “do” is displayed in the systolic display section and “PAr” is displayed in diastolic display section.
The monitor will be searchable from the receiver device for about one minute after pressing the start/stop button.
- ③ Follow the manual of the pairing receiver device, the monitor performs a search, select, and pair. If a PIN code is requested by the receiver device, enter "123456".
- ④ “End” is displayed in the pulse rate display section when the pairing is over successfully on the receiver device side, and the pairing is finished.
- ⑤ If the pairing is failed, “Err” is displayed in the pulse rate display section. Turn off the monitor and back on again, and then retry from the step ①.

NOTE

- Other than the operation of the above ②, the monitor will be searchable from the receiver device for about one minute after turning on the power. In this operation, “End/Err” are not displayed in the pulse rate display section when the pairing is over.
(※When reset with the **FAST STOP** button, searching is impossible.)
- Be sure to turn off the power of Bluetooth devices other than the monitor when pairing. Multiple devices cannot be paired at the same time.

3) Measurement data transmission

Transmission after pairing is performed automatically by the following procedure.

Enable wireless communication on the receiving device.

- ① Press the START/STOP button to start blood pressure measurement.
- ② After measurement, the measurement data is transmitted automatically to the receiver device.

NOTE

- When the function setting F20 of the Automatic Blood Pressure Monitor on which the monitor is installed is OFF, data transmission and reception are not performed. Ensure F20 is not set to OFF.
 - If the receiver device cannot receive measurement data, try pairing again.
-
- The communication distance between this monitor and the receiver device is dependent on the Bluetooth output class of the receiver device.
When the receiver device is a Class 1 Bluetooth device: Less than 100 m
When the receiver device is a Class 2 Bluetooth device: Less than 10 m
 - This distance depends on the conditions in the surrounding environment. Please check that the distance is acceptable for transmitting measurement data.

In cases when the receiver device cannot receive measurement data, the measurement data is temporarily stored in the monitor memory along with the measurement time. A total of 200 sets of measurement data can be automatically stored. When the amount of data exceeds 200 sets, the oldest data is deleted and the new data is stored.

The data stored in the memory is transmitted the next time a connection is successfully made to the receiver device, and when the reception is confirmed, it is removed automatically. The amount of data that can be stored temporarily may vary with the receiver device.

4) Bluetooth utility mode

Configure Bluetooth settings for this monitor in Bluetooth utility mode.

To change function settings, use the buttons located on the rear panel of the monitor while the monitor is in standby mode.

- ① Hold down the SELECT buttons and turn on the power.
“do” is displayed in the systolic display section and “PAr” is displayed in the diastolic display section, when the Bluetooth utility mode has started.
- ② Each time the SELECT button is pressed, the setting changes to “un” / “PAr” → “cLr” / ”dAt” → “do” / “PAr” →...
- ③ Each item can be performed using the START/STOP button.

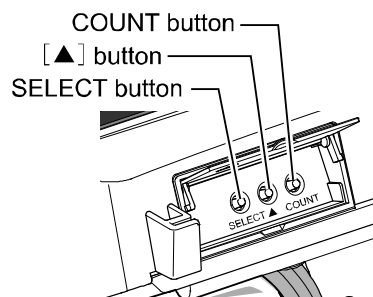

Pairing

See “11.2.3 2) Pairing” described above.

Unpairing

Devices can be unpaired.

Enter the Bluetooth utility mode. Press the START/STOP button with “un” in the systolic display section and “PAr” in the diastolic display section.

When “End” is displayed in the pulse rate display section, cancellation of the pairing is completed, but when “Err” is displayed in it, retry from the step ①.

Data clear

Erase data temporarily stored in the Automatic Blood Pressure Monitor.

Enter the Bluetooth utility mode. Press the START/STOP button with “cLr” in the systolic display section and “dAt” in the diastolic display section.

When “End” is displayed in the pulse rate display section, cancellation of the data clear is completed, but when “Err” is displayed in it, retry from the step ①.

NOTE

- This function is valid only with the TM2657-05.

5) Time

This monitor has a built-in clock. The measurement data includes the date and time that a measurement was taken.
 The time is designed to be synced with the time of a receiver device side. Refer to the specifications of the receiver device side.

NOTE	
	<ul style="list-style-type: none"> ■ The clock in the monitor can be automatically set by the receiver device side function. After the pairing, the time of the monitor is automatically set to the time of the receiver device 2 minutes after power on if there are no operations, or at the start of first measurement.
	<ul style="list-style-type: none"> ■ When the setting function F20 is off, the above clock synchronization is not performed.

6) Transmission specifications

Item	Specifications
Standard	Bluetooth Ver. 2.1 class 1 compatible with SPP and HDP
Transmission output	Class 1
Communication distance	Maximum of 100m (depends on usage)
Frequency band	2,402 - 2480 MHz
Maximum RF output power	20 dBm

This monitor has a built-in radio equipment with construction design certification required by regulations from the Radio Act.

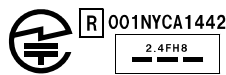

※This monitor may be changed for improvement without any prior notice.

NOTE	
	<ul style="list-style-type: none"> ■ Hereby, MITSUMI declares that the radio equipment type WML-C40AH is in compliance with Directive 2014/53/EU. The full text of the EU declaration of conformity is available at the following internet address: http://www.aandd.jp/products/manual/manual_medical.html

7) CONTENTS OF TRANSMISSION

Transmission data

Systolic blood pressure, diastolic blood pressure, pulse rate, measurement time, ID

For more information, please contact the A&D ME Device Customer Response Center.



12. MAINTENANCE

12.1. Inspection and safety management

Do not open the device. It uses delicate electronic components and an intricate air unit that could be damaged. If you cannot fix the problem using the troubleshooting instructions, request service from your local dealer or from the A&D service group. The A&D service group will provide technical information, spare parts and units to authorized dealers.

Technical inspection procedures which should be done at least every two years, can be performed either by the manufacturer or by an authorized repair service in accordance with the regulations governing manufacturing of medical products.

Checking pressure accuracy

 Caution	
	<ul style="list-style-type: none">■ When using a rubber pump, do not apply a pressure of 280 mmHg or higher to the monitor or inspection equipment (UM-101, accurate mercury sphygmomanometer or aneroid gauge).■ Perform the inspection only as described below or the setting values and function settings may be changed.
	<ul style="list-style-type: none">■ After inspection, check that the air connector plug is inserted into the blood pressure monitor. If the air connector plug is not inserted, pressure cannot be applied and measurement is not possible. When inserting the plug, push in until you hear a click.

Objective: Compare the pressure values of the inspection equipment and the blood pressure monitor to check for errors in the monitor.

Inspection equipment: Inspection equipment (UM-101, Accurate mercury sphygmomanometer or aneroid gauge)

Connection: Connect the inspection equipment to the blood pressure monitor as shown below. Remove the armrest of the blood pressure monitor and then remove the cover of pressure inspection area. Remove the air connector plug from the air socket of the blood pressure monitor. Connect the coupling connector to the connection hose, and connect it to the air socket.

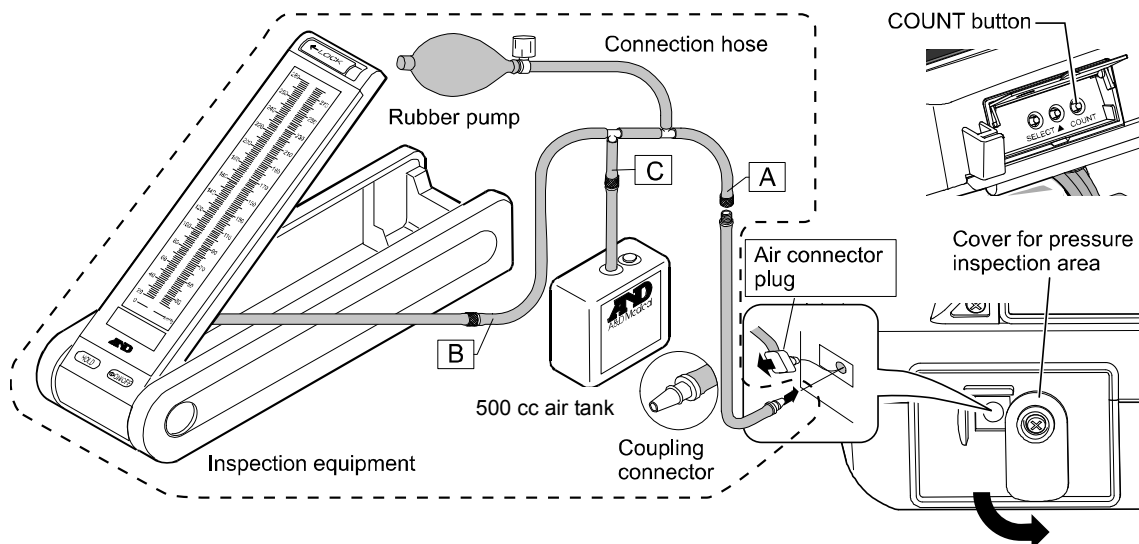

1. Hold the **COUNT** button on the rear of the blood pressure monitor, and turn the **POWER** switch on.
2. “**L30**” appears in the clock display section.
3. With “**L30**” displayed, press the **START/STOP** button.
Pressure inspection mode starts and the current pressure is displayed.
4. Using the rubber pump, apply the pressures listed below. Compare and check the pressures of the blood pressure monitor and the inspection equipment.

No	Pressure setting	Instrumental error A-B (standard)
1	0 mmHg	0 mmHg
2	50 mmHg	Within ± 6 mmHg
3	200 mmHg	

A: Pressure displayed by the inspection equipment

B: Diastolic and systolic pressures displayed by the monitor

5. Confirm that the values are within standards. To exit the pressure inspection mode and return to the standby mode, switch the power off and switch the power on again.

Note

- Use the coupling connector for exclusive use with the TM-2657P.

12.2. Cleaning

Caution



- Before cleaning, switch the power off and disconnect the power cable from the electrical outlet.
- When cleaning the monitor, never splash it with or soak it in water.
- The blood pressure monitor is not waterproof device. Do not splash water on it and avoid exposure to moisture.
- When disinfecting the monitor, never use an autoclave or gas sterilization (EOG, formaldehyde gas, high concentration of ozone).
- Never clean the monitor with solvents such as thinner or benzene.
Clean the monitor about once a month in the following manner based on policies and procedures determined by the hospital.

When the main body or the arm cuff cover is dirty, wipe them fully by using gauze or cloth dampened with warm water and a neutral detergent avoiding excess water.

To prevent a risk due to infection, disinfect the main body and the arm cuff cover regularly.

When disinfecting them, wipe them gently by using the gauze or dampened cloth with local antiseptic solution then wipe the moisture off the surface by using a dry soft cloth.

The antiseptic solution should be used as a water solution by following a rule for notes for its product at the dilution ratio. The following shows the example in which can be used as antiseptic solution.

-Sodium hypochlorite (0.06%) or isopropyl alcohol (50%)

Check that the arm cuff cover is not damaged. If it is damaged, replace it.



For the replacement procedure, see “12.4. Replacing the arm cuff cover”.

Note

- The arm cuff cover and cables are consumables.
If there are frequent measurement errors or measurement is not possible, these items must be replaced.
Before ordering replacements, see “13. ACCESSORIES AND OPTIONS LIST”.

Printer head

If the printer head has paper debris, or other foreign matter has collected, printing will not be performed correctly. To prevent this, follow the procedure below to clean the printer head.

 Caution	
	<ul style="list-style-type: none">■ Before cleaning, switch the power off and wait until the printer head has cooled completely. The printer head gets very hot and may cause burns.■ Some printer parts have sharp edges. Take great care when handling them to avoid injury.

1. Switch the power off.
2. Press the **Open printer cover** button to open the printer cover.

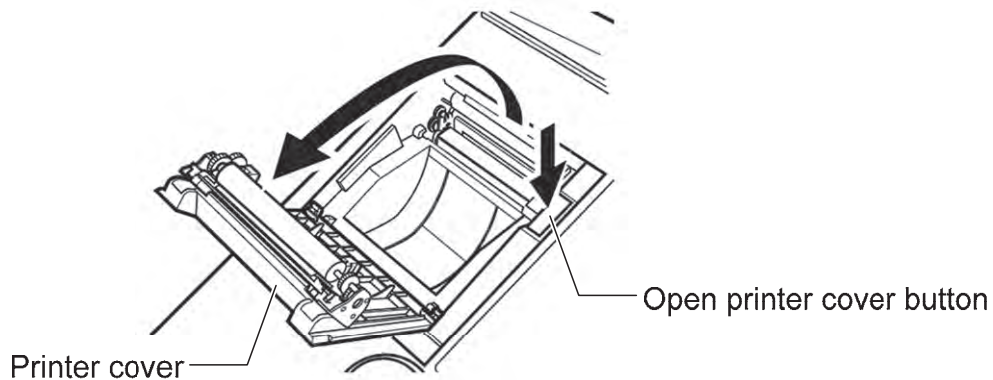

3. Using a soft cotton swab or cotton cloth moistened with alcohol (ethyl or isopropyl), clean the heating element very gently.

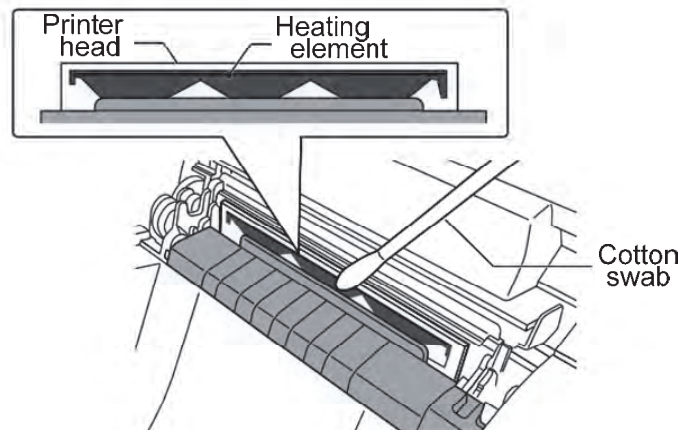

4. Clean the printer paper compartment to remove dust, paper debris and other foreign matter. Debris in the paper output path may lower the printing quality.
5. Wait for the cleaned parts to completely dry and install the printer paper.

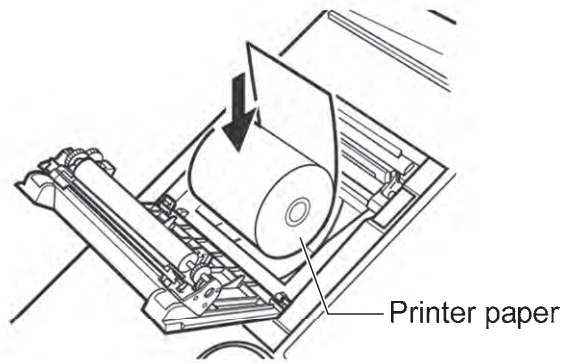

6. With the end of the paper at the top and protruding out, secure the printer paper by closing the printer cover until you hear a click. If the cover is not completely closed, a paper jam may occur.

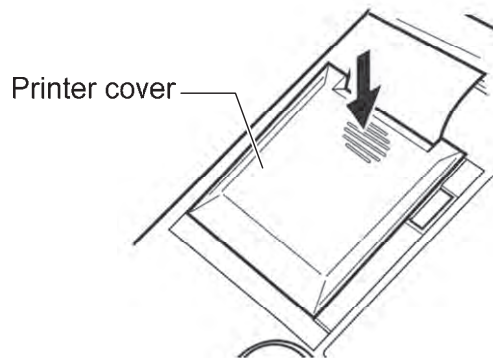

Note

- When cleaning the printer head, be careful of static electricity. Static electricity can damage the printer head.
- Do not use abrasive substances, such as sandpaper, to clean the printer head. They will damage the heating element.
- Make sure that the printer head is completely dry before installing the printer paper and switching the power on.

12.3. Periodic inspection

To ensure correct use of the monitor, perform a periodic inspection.

The main items of the periodic inspection are as follows.

Before switching the power on

Item	Description
Exterior	Check for deformations and damage from drops.
	Check parts for dirt, rust, scratches.
	Check panels for dirt, scratches, damage.
	Check for moisture.
Operation parts	Check switches and buttons for damage, looseness.
Display	Check display for dirt, scratches.
Measurement parts	Check the cuff and arm cuff cover for damage.
Arm cuff cover	Check that the arm cuff cover is installed. Please use the arm cuff cover to prevent any foreign matter from entering into this device.
Printer	Check that the printer paper is the specified type
Power parts	Check that the power cable is inserted correctly into the connector.
	Check the power cable for damage (exposed core wires, disconnection).
	Check that the electrical outlet is properly grounded and supplies the specified voltage and frequency (100-240 V~ 50-60 Hz).

After switching the power on

Item	Details
Exterior	Check for smoke or unusual smells.
	Check for unusual noise.
Operation parts	Press the START/STOP button and check for errors.
	Press the FAST STOP button during inflation to check that pressurization stops.
Display	Check the blood pressure, pulse and clock display sections for missing numbers or characters.
	Check that no error codes are displayed.
	Check that measurement values are near normal values.
Printer	Check that the paper availability and run out are detected.
	Check that the printer paper is fed correctly.
	Check that test printing has no missing items.
	Check that the paper is cut after printing.
Backup function	Check that the date and time are correct.
	Check that the contents of set values are saved.

12.4.Replacing the arm cuff cover

Front

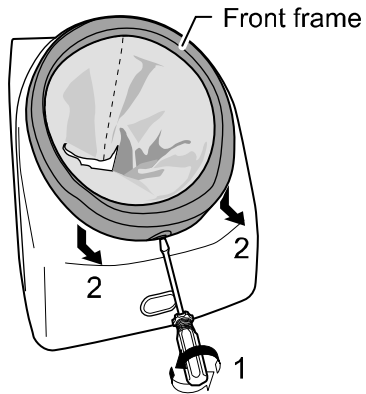

1. Use a flathead screwdriver to loosen the screw.
2. Slide the front frame down, and then pull forward.

Rear

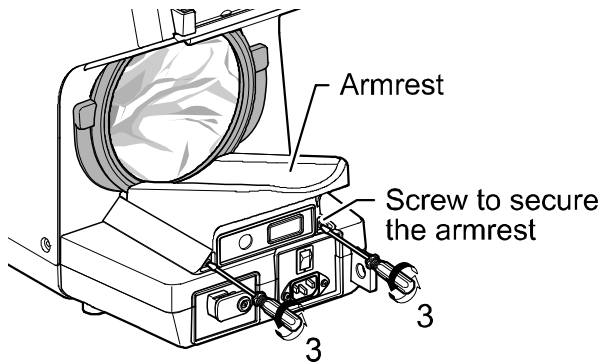

3. Loosen the screws (armrest securing screws) on the rear side and remove the screws.

Rear

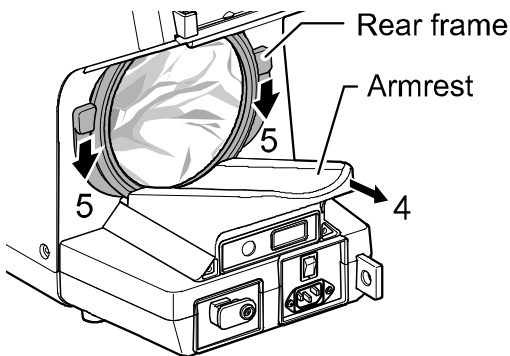

4. Lift the armrest and pull back.
5. Slide the rear frame down, then pull out.

Rear

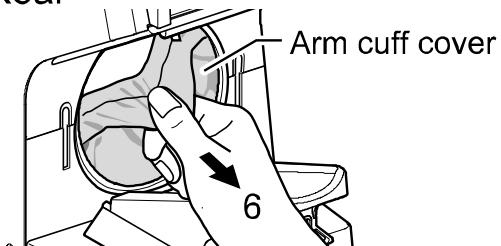

6. Pull the arm cuff cover out from the vinyl ring groove to remove.

Rear

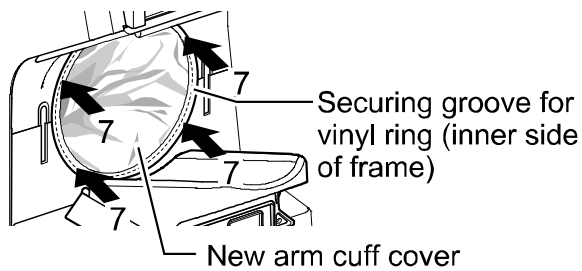

7. Insert the new arm cuff cover and push the vinyl ring into the groove (on the inner side of the frame) to attach.

Front

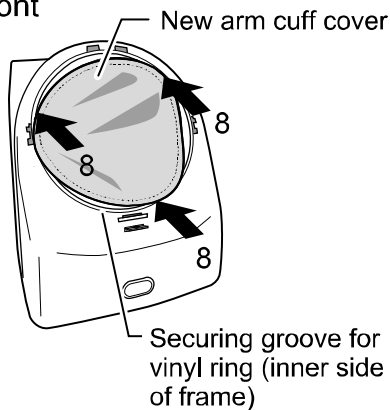

8. Fit the new arm cuff cover over the front vinyl ring groove.

9. Reversing the steps used to remove, reattach the rear and front frames, return the armrest to its original position, then replace the armrest securing screws (2) and front frame screw (1).

Note

- The arm cuff cover is consumable. New covers must be purchased separately.
(arm cuff cover : AX-134005759-S)



Caution

- Using a correct arm cuff cover and exchanging it are important for safety and measurement accuracy at this device.

12.5. Checking the number of measurements

The monitor can count the number of times blood pressure measurement has been performed. This function is designed to check usage frequency and provide a reference for scheduled cleaning. The count value is stored even after the power is switched off.

12.5.1. Displaying the number of measurements

To display the number of measurements:

Hold the **COUNT** button for 1 second while the monitor is in the standby mode. The number of measurements is displayed for about 60 seconds in the systolic and diastolic display sections.

In the example display below, the number of measurements is 2,382. (The maximum count is 999,999.)

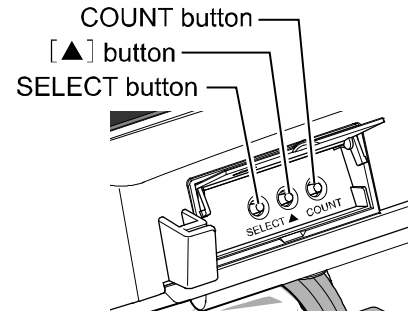
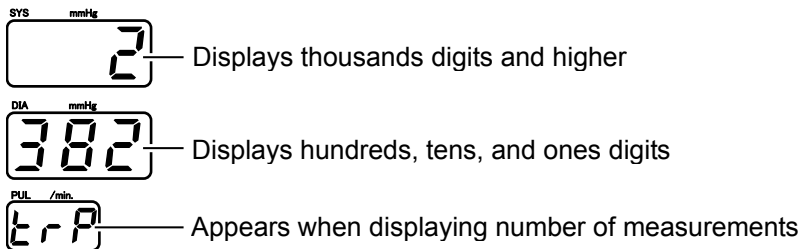

To reset the number of measurements:

Hold the **▲** button for 4 seconds to display the reset confirmation display. Press the **START/STOP** button to reset the count.

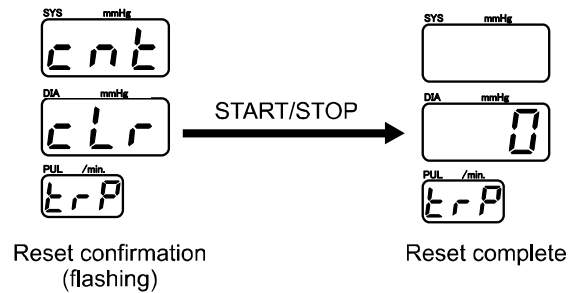

12.5.2. Printing the count graph

To print the count graph:

Press the **COUNT** button. While the number of measurements is displayed, press the **START/STOP** button to print the count graph.

- Total Count: Number of measurements since shipping
- Trip Count: Number of measurements since the last reset (See "12.5.1. Displaying the number of measurements")
- Weekly Count: A distribution of the number of measurements in the last week.
- Monthly Count: A distribution of the number of measurements in the last month.

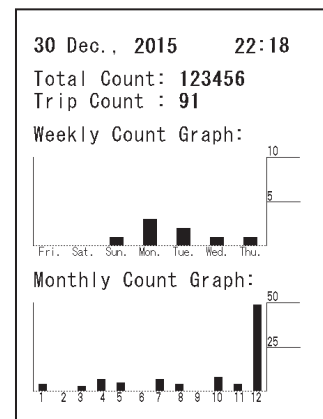

Note

- If the function **F07** is set to off, the count graph is not printed. (See "10.5. Print quality")
- After the count graph is printed, the number of measurements remains displayed for about 60 seconds.
- If "Low Battery" is printed in the lower left of the print out after the count graph is printed out, please contact your local A&D dealer.

12.6. Disposing of the component parts

Dispose of or recycle the monitor in an environmentally friendly manner according to local regulations.

Arm cuff cover

As there is a danger of infection, dispose of the arm cuff cover as medical waste.

Internal backup battery

The monitor is equipped with a lithium battery to back up settings and other data. Before disposing of the main unit, remove the lithium battery and dispose of it according to local regulations.

Product name	Model name	Structure name	Material
Package	—	Box	Cardboard
		Packing material	Cardboard
		Bag	Vinyl
Inside main unit	—	Case	ABS/ABS plastic
		Internal parts	General parts
		Chassis	Steel
		Battery on PCB	Lithium battery
Printer unit	—	Case	ABS/ABS plastic
		Internal parts	General parts
		Chassis	Steel
External input/output unit (Option)	—	Case	ABS/ABS plastic
		Internal parts	General parts

12.7. Before requesting service

Before requesting service, please review the following checklist and the error code list in the next section.

Problem	Check	Countermeasure
Nothing is displayed when the power is switched on.	Is the power cable connected correctly?	Connect the power cable correctly.
E00 is displayed.	Is there air remaining in the cuff?	Wait until the air is released completely from the cuff, and then switch the power on again.
There is no pressure.	Is the arm cuff cover pulled too far over the frames?	See "12.4. Replacing the arm cuff cover" to reattach the arm cuff cover correctly.
Measurement is not possible. (An error code is displayed.)	Is the patient's posture correct?	Ensure that the arm and heart are at the same height and that the patient is relaxed.
	Is the patient relaxed?	Ensure that the patient does not move their arm.
	_____	If clothing is too thick, measurement is not possible. Remove the clothing from the arm.
	_____	Measurement may not be possible with patients with arrhythmia or a weak pulse.
No printing	The printer paper is not installed. (P E is displayed)	See "9.1. Installing the printer paper" to install a new roll of printer paper.
	The printer cover is open. (P □ is displayed)	See "9.1. Installing the printer paper" to close the printer cover.
	A printer cutter error. (P C is displayed)	See "9.1. Installing the printer paper" to temporarily open the printer cover and then close it again.
	Is the printer paper causing a jam?	See "9.1. Installing the printer paper", readjust the paper.
The printing content was not as expected.	Is the printing method selection appropriate?	See Sections "10.4. IHB" to "10.10. Bitmap printing" to select the printing method.
Date and/or time are off.	Check the clock setting.	Refer to "8.SETTING THE CLOCK"
	Is the Low Battery printed on the lower left of the print out after the count graph is printed as shown in 12.5.2?	The lithium battery for back up settings and other data is dead. Contact your local A&D dealer.
	Check the clock setting on the Bluetooth receiver.	See the specifications of the receiver device.

Caution



- Do not touch the interior of the monitor.

12.8. Error codes

When an error occurs, one of the following error codes is displayed in the systolic display section.

Printer error codes

Error code	Error/countermeasure
<i>PE</i>	No printer paper. Install a new roll of printer paper.
<i>Po</i>	The printer cover is open. Firmly close the printer cover.
<i>Pc</i>	A printer cutter error. Open the printer cover, check the printer paper, and then close the printer cover.

Error code details

Error code	Details	Check items
Error related to blood pressure measurement		
<i>E00</i>	When the power is switched on, the pressure detection is unstable.	Check if there is air remaining in the cuff. Restart and then try blood pressure measurement again. If the problem continues, stop using the monitor immediately.
<i>E08</i>	An electrical error is detected in the blood pressure measurement section.	Restart and then try blood pressure measurement again. If the problem continues, stop using the monitor immediately.
<i>E09</i>	The safety monitor of the blood pressure measurement section detected an error.	A condition that may affect the safety of the patient was detected during measurement. External vibrations may have been applied to the air system of the cuff or inside the monitor or an obstruction may have been mistakenly detected. Check the patient condition and measurement environment and try blood pressure measurement again. If the problem continues, stop using the monitor immediately.
<i>E11, E15</i>	Pressure is not applied at the start of the measurement.	There may be an air leak in the air system inside the monitor. If the problem continues, stop using the monitor immediately.
<i>E12</i>	Pressure cannot be applied within a certain period of time.	There may be a leak in the air system inside the monitor or the cuff was applied loosely. If the problem continues, stop using the monitor.
<i>E13</i>	Inflation speed is too fast.	There may be a bend or blockage in the air system inside the monitor. If the problem continues, stop using the monitor.
<i>E21</i>	The exhaust speed is too slow.	Air is not being correctly exhausted. There may be a bend or blockage in the air system inside the monitor. If the problem continues, stop using the monitor.
<i>E22</i>	The exhaust speed is too fast.	The patient may have moved or a strong external pressure was applied during measurement. If the problem continues, stop using the monitor.

Error code	Details	Check items
E23	Excess pressure was detected.	The cuff pressure during measurement exceeded 300 mmHg. The patient may have moved or a strong external pressure was applied to the cuff. Watch for errors and try measurement again.
E24	The time limit for one measurement was exceeded.	For the safety of the patient, measurement was cancelled because the measurement time exceeded 180 seconds. Measurement may have been repeated. Check the patient for body movement and arrhythmia.
E42	The pressure is insufficient.	Blood pressure measurement was not possible because the pressure was insufficient. During inflation, patient movement or an external vibration introduced noise into the cuff pulse and the set pressure was detected or the patient's blood pressure rose greatly during blood pressure measurement. Confirm the following conditions: The cuff is not loose; no thick clothing on the arm; the patient remains still; and no external vibrations on the cuff. And try measurement again.
E43	Pulse cannot be detected.	The pulse signal received by the cuff is too low. The circulation of the patient may be poor or the patient is wearing thick clothing. Check the condition of the patient.
E45	Diastolic blood pressure cannot be determined.	Check the patient for body movement and arrhythmia.
E46	Mean arterial blood pressure cannot be determined.	
E48	Systolic blood pressure cannot be determined.	
E61	Pulse cannot be determined.	
E63	The blood pressure value is inappropriate.	
E63 1	SYS value is 'out of range'.	SYS measurement range : 40-270 mmHg Check the patient for body movement and arrhythmia.
E63 2	DIA value is 'out of range'.	DIA measurement range : 20-200 mmHg Check the patient for body movement and arrhythmia.
E63 3	PUL value is 'out of range'.	PUL measurement range : 30-240 mmHg Check the patient for body movement and arrhythmia.

Error code	Details	Check items
Other errors		
E97 1 to 4	Restart the power. A power voltage error was detected inside the monitor.	Restart the power. If the problem continues, stop using the monitor immediately.
E97 5	Restart the power. A setting error was detected inside the monitor.	The function settings have been initialized. Check the settings. Restart the power. If the problem continues, stop using the monitor immediately.
E97 6	Restart the power. A setting error was detected inside the monitor.	The counting function has been initialized. Restart the power. If the problem continues, stop using the unit for the time being.
E97 8, 9	Restart the power. A setting error was detected inside the monitor.	Restart the power. If the problem continues, stop using the monitor immediately.
E98 1	Restart the power. A memory error was detected inside the monitor.	Restart the power. If the problem continues, stop using the monitor immediately.
E99 1	There may be a malfunction. A font error was detected.	Restart the power. If the problem continues, stop using the monitor immediately and request repairs.
E99 2	There may be a malfunction. A cuff error was detected.	
E99 3	There may be a malfunction. A blood pressure module error was detected.	

Displaying the error status

Press the **COUNT** button. The count is displayed. Press the **SELECT** button within 60 seconds. The past error codes (systolic display section), error sub codes (diastolic display section) and the number of occurrences (pulse display section) are displayed. Each time the **SELECT** button is pressed, past error codes are displayed in numerical order.

After 60 seconds of no operation, the monitor returns to standby mode.

13. ACCESSORIES AND OPTIONS LIST

Product name	Catalog Number
Printer paper (5 rolls)	AX-PP147-S
Arm cuff cover	AS-134005759-S (5pieces)
Power cable (cord set)	AX-KO243 (Type C)
Power cable (cord set)	AX-KO242 (Type BF) Fuse rating: T3AH250V
Power cable (cord set)	AX-KO115-EX (Type A)
External input/output unit RS 2ch	TM-2657-01-EX
External input/output unit RS 1ch	TM-2657-03-EX
External input/output unit RS+Bluetooth	TM-2657-05-EX

14. ABOUT BLOOD PRESSURE

Blood pressure variations

Blood pressure is highly sensitive and changes subtly with each beat to match the condition of the heart. It may vary by 30 to 50 mmHg in response to various conditions.

That's why it's important not to focus on a single measurement, but instead measure every day at the same time to learn your average blood pressure and blood pressure trends. This blood pressure information will be important when visiting a doctor. Consult with a doctor to determine the meaning of your results.

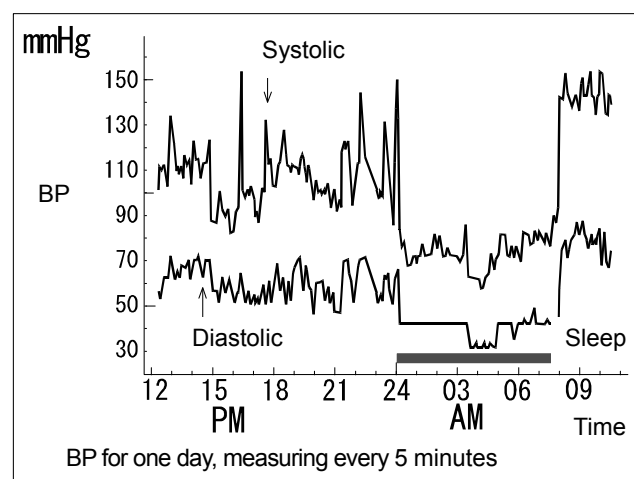

What types of high blood pressure are there?

There are 2 types of high blood pressure: essential hypertension and secondary hypertension. Secondary hypertension is caused by disease that raises blood pressure. When kidney inflammation or pregnancy toxicosis causes high blood pressure, treat the problem and the blood pressure will fall naturally.

In the case of essential hypertension, the cause is not clear, but the blood pressure is high. The combination of long periods of stress, high salt intake, obesity and genetic problems can cause essential high blood pressure. Of these causes, genetics play a large factor. If both or one parent has high blood pressure, the occurrence rate of high blood pressure is 60% and 30%, respectively, indicating a genetic component.

15. SENDING BITMAP PATTERNS

15.1. Size of original bitmap patterns

Width: 384 pixels (fixed) (Bitmap data other than 384 pixels in width cannot be sent.)

Length: maximum 640 pixels (Bitmap data of an optional length from 1 to 640 pixels can be sent.)

The maximum size of original bitmap patterns is as shown below:

(Windows monochrome bitmap)

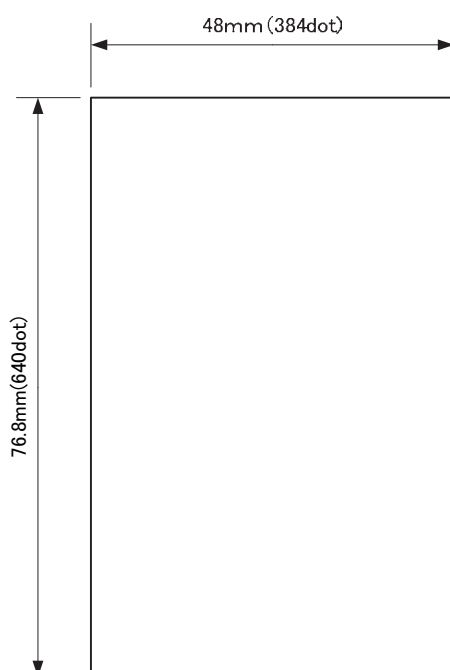

Create the bitmap data of the abovementioned size with a file name “Logo.bmp” and save it in the root folder of the SD card.

Note

- For operable SD card standard, the device operation is checked with SD and SDHC. Some SD cards cannot be recognized with the device. In that case, please use other SD card.
- For a file system, the device operation is checked with FAT16 and FAT32.

15.2. Sending bitmaps

1. Switch off the power of the monitor.

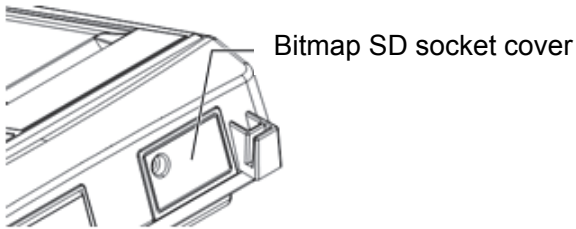

2. With the **COUNT**, **▲** and **SELECT** buttons pressed, switch the power on. The monitor enters the bitmap transfer mode.

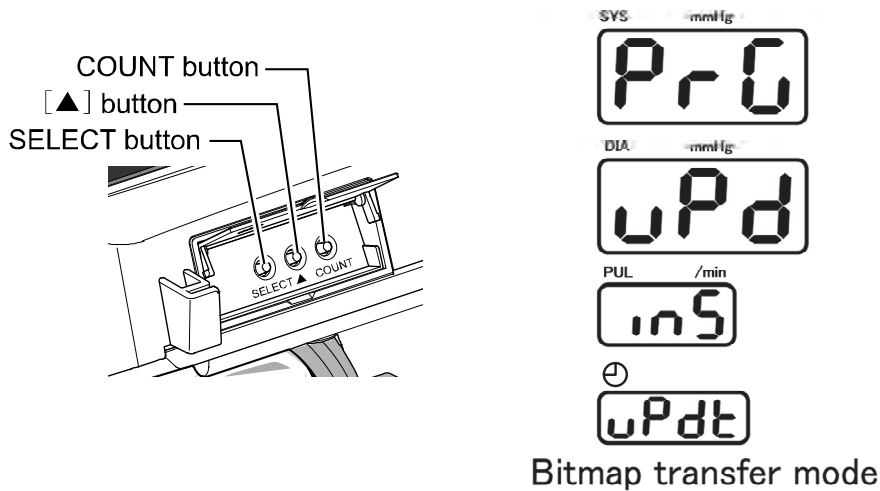

3. Insert the SD card containing the bitmap file (Logo.bmp) saved in “15.1. Size of original bitmap patterns” into the SD socket. Press the START/STOP button to start data transfer.

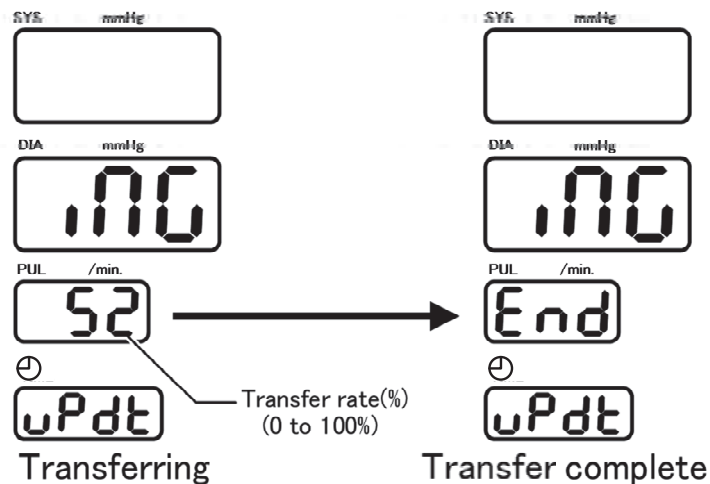

After transfer, restart the power, and then set the function **F15** to **2**. The bitmap is printed with the blood pressure value after blood pressure measurement.

APPENDIX: EMC INFORMATION

Medical electrical equipment requires special precautions regarding EMC and must be installed and put into service according to the EMC information provided below.

Portable and mobile RF communication equipment (e.g. cell phones) can affect medical electrical equipment.

The use of accessories and cables other than those specified (other than A&D original parts) may result in increased emissions or decreased immunity of the unit.

Guidance and manufacturer's declaration – electromagnetic emissions		
The A&D unit is intended for use in the electromagnetic environment specified below. The customer or the user of the A&D unit should assure that it is used in such an environment.		
Emissions test	Compliance	Electromagnetic environment – guidance
RF emissions CISPR 11	Group 1	The A&D unit uses RF energy only for its internal function. Therefore, its RF emissions are very low and are not likely to cause any interference in nearby electronic equipment.
RF emissions CISPR 11	Class B	The A&D unit is suitable for use in all establishments, including domestic establishments and those directly connected to the public low-voltage power supply network that supplies buildings used for domestic purposes.
Harmonic emissions IEC 61000-3-2	Class A	
Voltage fluctuations/flicker emissions IEC 61000-3-3	Complies	

Recommended separation distances between portable and mobile RF communications equipment and the A&D unit			
The A&D unit is intended for use in an electromagnetic environment in which radiated RF disturbances are controlled. The customer or the user of the A&D unit can help prevent electromagnetic interference by maintaining a minimum distance between portable and mobile RF communications equipment (transmitters) and the A&D unit as recommended below, according to the maximum output power of the communications equipment.			
Rated maximum output power of transmitter W	Separation distance in meters according to frequency of transmitter		
	150 kHz to 80 MHz $d = 1.2\sqrt{P}$	80 MHz to 800 MHz $d = 1.2\sqrt{P}$	800 MHz to 2.5 GHz $d = 2.3\sqrt{P}$
0.01	0.12	0.12	0.23
0.1	0.38	0.38	0.73
1	1.2	1.2	2.3
10	3.8	3.8	7.3
100	12	12	23
For transmitters rated at a maximum output power not listed above, the recommended separation distance d in metres (m) can be estimated using the equation applicable to the frequency of the transmitter, where p is the maximum output power rating of the transmitter in watts (W) according to the transmitter manufacturer.			
NOTE 1 At 80 MHz and 800 MHz, the separation distance for the higher frequency range applies.			
NOTE 2 These guidelines may not apply in all situations. Electromagnetic propagation is affected by absorption and reflection from structures, objects and people.			

Guidance and manufacturer's declaration – electromagnetic immunity

The A&D unit is intended for use in the electromagnetic environment specified below. The customer or the user of the A&D unit should assure that it is used in such an environment.

Immunity test	IEC 60601 test level	Compliance level	Electromagnetic environment – guidance
Conducted RF IEC 61000-4-6 Radiated RF IEC 61000-4-3	3 V _{rms} 150 kHz to 80 MHz 3 V/m 80 MHz to 2,5 GHz	3 V _{rms} 3 V/m	<p>Portable and mobile RF communications equipment should be used no closer to any part of the A&D unit, including cables, than the recommended separation distance calculated from the equation applicable to the frequency of the transmitter.</p> <p>Recommended separation distance:</p> $d = 1.2 \sqrt{P}$ $d = 1.2 \sqrt{P} \quad 80 \text{ MHz to } 800 \text{ MHz}$ $d = 2.3 \sqrt{P} \quad 800 \text{ MHz to } 2,5 \text{ GHz}$ <p>where P is the maximum output power rating of the transmitter in watts (W) according to the transmitter manufacturer and d is the recommended separation distance in metres (m).</p> <p>Field strengths from fixed RF transmitters, as determined by an electromagnetic site survey,^a should be less than the compliance level in each frequency range.^b</p> <p>Interference may occur in the vicinity of equipment marked with the following symbol: </p>

NOTE 1 At 80 MHz and 800 MHz, the higher frequency range applies.

NOTE 2 These guidelines may not apply in all situations. Electromagnetic propagation is affected by absorption and reflection from structures, objects and people.

^a Field strengths from fixed transmitters, such as base stations for radio (cellular/cordless) telephones and land mobile radios, amateur radio, AM and FM radio broadcast and TV broadcast cannot be predicted theoretically with accuracy. To assess the electromagnetic environment due to fixed RF transmitters, an electromagnetic site survey should be considered. If the measured field strength in the location in which the A&D unit is used exceeds the applicable RF compliance level above, the A&D unit should be observed to verify normal operation. If abnormal performance is observed, additional measures may be necessary, such as re-orienting or relocating the A&D unit.

^b Over the frequency range 150 kHz to 80 MHz, field strengths should be less than 3 V/m.

Guidance and manufacturer's declaration – electromagnetic immunity

The A&D unit is intended for use in the electromagnetic environment specified below. The customer or the user of the A&D unit should assure that it is used in such an environment.

Immunity test	IEC 60601 test level	Compliance level	Electromagnetic environment – guidance
Electrostatic discharge (ESD) IEC 61000-4-2	± 6 kV contact ± 8 kV air	± 6 kV contact ± 8 kV air	Floors should be wood, concrete or ceramic tile. If floors are covered with synthetic material, the relative humidity should be at least 30%.
Electrical fast transient/burst IEC 61000-4-4	± 2 kV for power supply lines ± 1 kV for input/output lines	± 2 kV for power supply lines ± 1 kV for input/output lines	Mains power quality should be that of a typical commercial or hospital environment.
Surge IEC 61000-4-5	± 1 kV line to line ±2 kV line to earth	± 1 kV line to line ±2 kV line to earth	Mains power quality should be that of a typical commercial or hospital environment.
Voltage dips, short interruptions and voltage variations on power supply input lines IEC 61000-4-11	< 5% U_T (> 95% dip in U_T) for 0.5 cycle 40% U_T (60% dip in U_T) for 5 cycles 70% U_T (30% dip in U_T) for 25 cycles < 5% U_T (> 95% dip in U_T) for 5 s	< 5% U_T (> 95% dip in U_T) for 0.5 cycle 40% U_T (60% dip in U_T) for 5 cycles 70% U_T (30% dip in U_T) for 25 cycles < 5% U_T (> 95% dip in U_T) for 5 s	Mains power quality should be that of a typical commercial or hospital environment. If the user of the A&D unit requires continued operation during power mains interruptions, it is recommended that the A&D unit be powered from an uninterruptible power supply or a battery.
Power frequency (50/60 Hz) magnetic field IEC 61000-4-8	3 A/m	3 A/m	Power frequency magnetic fields should be at levels characteristic of a typical location in a typical commercial or hospital environment.

NOTE : U_T is the AC mains voltage prior to application of the test level.