

Multi-parameter Veterinary Monitor

User Manual

Contents

Disclaimer Statement.....	1
Chapter One General Introduction to Product	3
1.1 monitor overview	4
1.2 Display Interface.....	6
1.3 Key functions and Basic Operations.....	10
1.4 External Interfaces and Plug-in module box.....	11
1.5 Internal Chargeable Battery	13
Chapter Two Animal Monitor Installation.....	14
2.1 Unpacking Inspection	14
2.2 Electric Connection	14
2.3 Power On	14
2.4 Connection of Sensor.....	15
2.5 Inspection on Recorder.....	15
Chapter Three System Menu	16
3.1 Animals' Information Management	16
3.2 Default Configuration	17
3.3 Retrospective Function	18
3.3.1 Retrospection of NIBP.....	18
3.3.2 Retrospection of alarm event.....	19
3.3.3 Retrospection of trend plot	20
3.3.4 Retrospection of trend table.....	21
3.3.5 Retrospection of trend wave	22
3.4 Information of Animal Monitor	23
3.5 Setting Animal Monitor	23
3.5.1 Work Interface Selection.....	24
3.5.2 Alarm limit display	24
3.5.3 Alarm recording time.....	24
3.5.4 Alarm pause time	24
3.5.5 Alarm sound setting	24
3.5.6 Key volume setting	25
3.5.7 System Time Setting.....	25
3.5.8 Record output setting.....	25
3.5.9 Event Setting.....	26
3.6 Maintenance of animal monitor	26
3.7 Demonstration Function	26
Chapter Four Animals' Safety	28
Chapter Five Maintenance and Cleaning.....	31
5.1 Maintenance and Test.....	31
5.2 General cleaning	31
5.3 Application of Cleanser	31
5.4 Disinfection and Sterilization	32
5.5 Disinfection	32

Chapter Six Alarm	33
6.1 General Introduction to alarm	33
6.2 Alarm Property	33
6.2.1 Type of Alarm	33
6.3 Alarm Prompt Method	34
6.3.1 Sound and Light Property	34
6.3.2 Character property	35
6.3.3 Others	35
6.4 Alarm State	35
6.4.1 General Introduction to Alarm State	35
6.4.2 Alarm Mute State	35
6.4.3 Alarm Sound Closedown State	35
6.4.4 Alarm Timeout State	35
6.4.5 State Switch-over	36
6.5 Alarm Method	36
6.5.1 General Introduction	36
6.5.2 Scope of Application	36
6.5.3 Latch-up Alarm Prompt	36
6.5.4 Removing Latch-up Method	37
6.6 Alarm Setting	37
6.6.1 Sound On/Off Setting	37
6.6.2 Automatic Alarm Closedown	38
6.6.3 Power-on Lead fail	38
6.7 Parameter alarm	38
6.8 Measures Taken in Case of Alarm	38
Chapter Seven Recorder (Optional)	39
7.1 General Information of Recorder	39
7.2 Type of Record	39
7.3 Record Output	39
7.4 Information of Recorder's Operation and State	40
Chapter Eight Electrocardiogram and Respiration (ECG/RESP)	41
8.1 ECG Monitoring Instruction	41
8.1.1 Definition of ECG Monitoring	41
8.1.2 Precautions for ECG Monitoring	41
8.2 Operation Method of ECG Monitoring	41
8.2.1 Preparation	41
8.2.2 Installation of ECG Lead	42
8.3 ECG Menu	44
8.4 ECG alarm Information	47
8.5 ST Segment Monitoring	47
8.6 Respirometry	50
8.7 Maintenance and Cleaning	52
Chapter Nine Blood Oxygen Saturation (SpO ₂)	53
9.1 SpO ₂ Monitoring Instruction	53

9.2 Operating method of SpO2 monitoring.....	54
9.3 Measurement Limit of SpO2 Monitoring.....	55
9.4 SpO2 Menu	55
9.5 SpO2 Alarm Information	57
9.6 Maintenance and Cleaning.....	57
Chapter Ten Temperature (TEMP)	58
10.1 TEMP Monitoring Instruction	58
10.2 TEMP Menu	58
10.3 TEMP Alarm Information and Prompt Information	59
10.4 Maintenance and Cleaning.....	59
Chapter Eleven Non-invasive Blood Pressure (NIBP)	61
11.1 NIBP Monitoring Instruction	61
11.2 Operating method for NIBP Monitoring.....	61
11.2.1 NIBP Measurement.....	61
11.2.2 NIBP Parameter Setting and adjustment.....	64
11.3 NIBP Menu	64
11.4 Maintenance and Cleaning.....	67
Chapter Twelve IBP Monitoring (Optional)	69
12.1 Introduction	69
12.2 Precautions during IBP Monitoring	69
12.3 Monitoring Procedure.....	70
12.4 IBP Menu	71
12.5 Alarm Information and Prompts	77
12.6 Maintenance and Cleaning.....	79
Chapter Thirteen CO2 Measuring (Optional).....	81
13.1 General.....	81
13.2 Monitoring Procedure.....	82
13.3 CO2 Menu	82
13.3.1 Parameter Setup and Adjustment.....	82
13.3.2 CO2 other step	84
13.4 Alarm Information and Prompt.....	87
13.5 Maintenance and Cleaning.....	89
Manufacturer's Declaration of the EUT	90
Appendix I: Product Specification.....	94
I.1 ECG Specification	94
I.2 RESP Specification	95
I.3 NIBP Specification	96
I.4 SpO2 Specification.....	96
I.5 TEMP Specification	97
I.6 IBP Specification	97
I.7 CO2 Specification.....	97

Disclaimer Statement

Gives no warranty in relation to the mistakes, mis-installation and mis-operation. The company undertakes no liability to accidental failure or inevitable damage.

The content of this user's manual is under the protection of copyright law. All rights reserved. With no prior consent from the company, reproduction, photographing, reprography or translation into other languages of any part of the manual are prohibited.

The company is responsible for the reliability, security and performance of the equipment only in the cases of the followings that: assembly, expansion, readjustment, performance improvement and maintenance are performed by authorized personnel or unit by our company; the electrical equipments are in compliance with the state relevant standards; operation of this equipment is followed this manual.

The company reserves the right to make change of the content of this manual without further notice.

the latest revision date: 01-2018



If veterinary clinic or medical units using the equipment have not a satisfied maintenance scheme available, failure of the equipment may be caused in and that may endanger the human and animal health.

Quality assurance:

Maintenance

Free service:

Free service is available for all the equipments within the scope of warranty service of Company.

Charge service:

- (1) Charge service is available for the equipments beyond the scope of warranty service of Company;
- (2) During warranty period, product servicing caused by the following reasons: mis-use; overvoltage, force majeure.

company undertakes no liability in relation to direct, indirect and final damage or delay because of the following (including but limited to) reasons: improper use; substituting component with those unauthorized by Company or maintenance performed by personnel unauthorized by Company.

Returning the machine

Procedures of returning the goods

If goods returning is needed, please follow the following steps:

1. Acquiring return permit: Contact with the After-sales Service Department of our company to offer the serial number of the product. If the serial number is not clear enough, goods returning will be refused. Please give clear indication of product model, serial number and a brief statement for reasons of returning the goods.
2. Freight: Users have to bear the freight (including customs charge) if product servicing is needed to be performed at our company.

Product Structure:

The monitor is a portable multi-parameter monitor which may used in monitoring vital signs of large animal, middle animal and small animal.

The monitor is power supplied by internal battery or AC. It is equipped with a handle for easy carrying.

Application scope:

The monitor is suitable for monitoring and measuring animals' vital signs of heart rate/pulse rate, electrocardiogram, blood oxygen saturation, respiration rate, temperature, non-invasive blood pressure (systolic blood pressure, diastolic blood pressure, mean blood pressure), invasive blood pressure (systolic blood pressure, diastolic blood pressure, mean blood pressure)(optional), end-tidal carbon dioxide(optional) and other physiological parameters in veterinary clinic

Use environment and cautions:

- This product is not home therapy equipment.
- Please fix secure the equipment to avoid injury to people and damage against the equipment.
- Keep the equipment away from MRI equipment to avoid animals' burn caused by inductive current.
- Keep the equipment away from the working place with flammable anesthetic gas or other gas.
- Keep the equipment away from the place with electromagnetic radiation, e.g. the place using mobile phone.
- Maintenance is to be performed only by qualified technicians.
- Substituting the power cord of this equipment is prohibited. Do not plug the three core power cord into the 2-pole socket.
- Keep it away from animal, the equipment and sickbed during defibrillation.

Precautions:

- Calibrate and ensure normal operation of the equipment before use.
- Pay attention to the power cord, conduit and all the cables to prevent animal from strangulation and other people from trip.
- Keep the back of the equipment open for heat elimination.
- Disconnect the power supply immediately in case of liquid falling into the case of the equipment and contact the maintenance personnel.

Chapter One General Introduction to Product

- Please read through the content of the monitor summarization for an overall understanding of the animal monitor.
- Please refer to screen display introduction for instruction of information displayed on the screen.
- Please refer to the content involving key functions and basic operation of the equipment for command of operation method.
- Please refer to the content involving external interface for interface position.
- Please refer to the content involving internal chargeable battery for precautions for the monitor power supplied by battery.



Portable multi-parameter monitor is used for clinical monitoring. Only professionals are allowed to use it.



Do not open the case of the equipment to avoid electrical shock. Only the maintenance personnel trained and authorized by are allowed to perform the maintenance and upgrade of the equipment.



Keep use of the equipment away from the place with flammable substances like anesthetic to avoid explosion.



Users are required to check if the equipment and the components work normally before use.



To avoid delay in medical treatment, please set proper alarm according to each animal and make alarm sound available with the alarm.



Do not use mobile phone near the equipment. The over-strong radiated field generated by mobile phone may interfere with the function of the animal monitor.



Keep away from animal, table and equipment during defibrillation.



The equipment connected to the animal monitor must be formed to be an equipotential body (protective and effective connection).



While using this equipment together with electrical surgical equipments, users should ensure the monitored animal safe.



Control the packing material according to the valid waste control standard, and keep the packing material beyond the touch of children.



It is a must to control the product and the components in this manual according to the relevant standard when they are to expire. Please contact its representatives for detailed information.



In case of the perfection and arrangement of the external earthing of the equipment are doubtful, it is a must to operate it using the internal battery.

1.1 monitor overview

Portable multi-parameter monitor features novel industrial design, small size and AC/DC power supply. It is equipped with a handle and internal battery for the convenience of animals' moving. The equipment is used to monitor and measure animals' vital signs of heart rate/pulse rate, electrocardiogram, blood oxygen saturation, respiration rate, temperature, non-invasive blood pressure (systolic blood pressure, diastolic blood pressure, mean blood pressure), invasive blood pressure (systolic blood pressure, diastolic blood pressure, mean blood pressure)(optional), end-tidal carbon dioxide(optional) and other physiological parameters.

boasts the following characteristics:

- ☆ 8", 10.4", 12.1", 15" screen with true color, wide viewing angle, high brightness can touch LCD display.
- ☆ Simple and friendly operating display interface.
- ☆ Internal chargeable large capacity battery provides convenience for animals' moving.
- ☆ Playback and browse function for long term waveform and monitor data record.
- ☆ Optional printing output function, alarm triggers printing.
- ☆ Auto double alarm with audible and visible signals
- ☆ Anti-defibrillation, anti-interference from high frequency electric knife
- ☆ A full-synchronistic lead multi-channel ECG display

Intended use:

The monitor is suitable for measuring heart rate/pulse rate, electrocardiogram, blood oxygen saturation, respiration rate, temperature, non-invasive blood pressure (systolic blood pressure, diastolic blood pressure, mean blood pressure), invasive blood pressure (systolic blood pressure, diastolic blood pressure, mean blood pressure)(optional), end-tidal carbon dioxide(optional) and other physiological parameters. It is suitable on large animal, middle animal and small animal. It can be used in veterinary clinic and research unit,

Contraindications : Not found

Working environment

Temperature:

Working temperature	0 — 40 °C
Transportation and storage temperature	-20 — 60 °C

Humidity:

Working humidity	≤ 85 %
Transportation and storage humidity	≤ 93 %

Altitude:

Working altitude	-500 — 4,600m(-1,600 — 15,000feet)
Transportation and storage altitude	-500—13,100m(-1,600 — 43,000feet)

Voltage



100—240 (V)AC, 50/60 (Hz)
 Pmax=70VA
 FUSE T 3.0A

enjoys a large range of multi-parameter monitor functions (as shown in picture 1-1). It is suitable for sickbed monitoring of large animal, middle animal and small animal. Users may choose different measuring parameter configuration according to different need.

It integrates parameter measuring module function with output display and recording to contribute to an impact and portable monitor. The internal battery provides the animal with an easy moving. 5 waveforms and all monitoring parameter data are displayed on the display interface with high resolution.

INTRODUCTION OF THE KEY ON THE MONITOR FOR E-MODEL :

Power switch “” of the equipment locates on the left side of front window (As shown in picture 1-1 ①) .

AC indicator “” locates at the right side of the power switch. When AC power is supplied, this indicator lights up in green. Charge indicator“POWER” locates under the AC indicator “” .When the equipment is power supplied by internal battery, it keeps lightening in green. (As shown in picture 1-1 ② and ③). Alarm indicator ALARM locates at the top right part of the set. When an alarm is given, this indicator flashes (As shown in picture 1-1 ⑦). Sensor jack locates at bottom left side of the front window 1 (As shown in picture 1-1 ⑧). Recorder locates at top left side of the set (As shown in picture 1-1 ⑥). Other jacks and power socket locate at the back window.

It has a friendly operation interface. All operations can be achieved by keys and knobs on the front window (As

shown in picture 1-1④and ⑤). ⑨Plug-in module box. Please refer to the content of Functional Keys for detailed information.

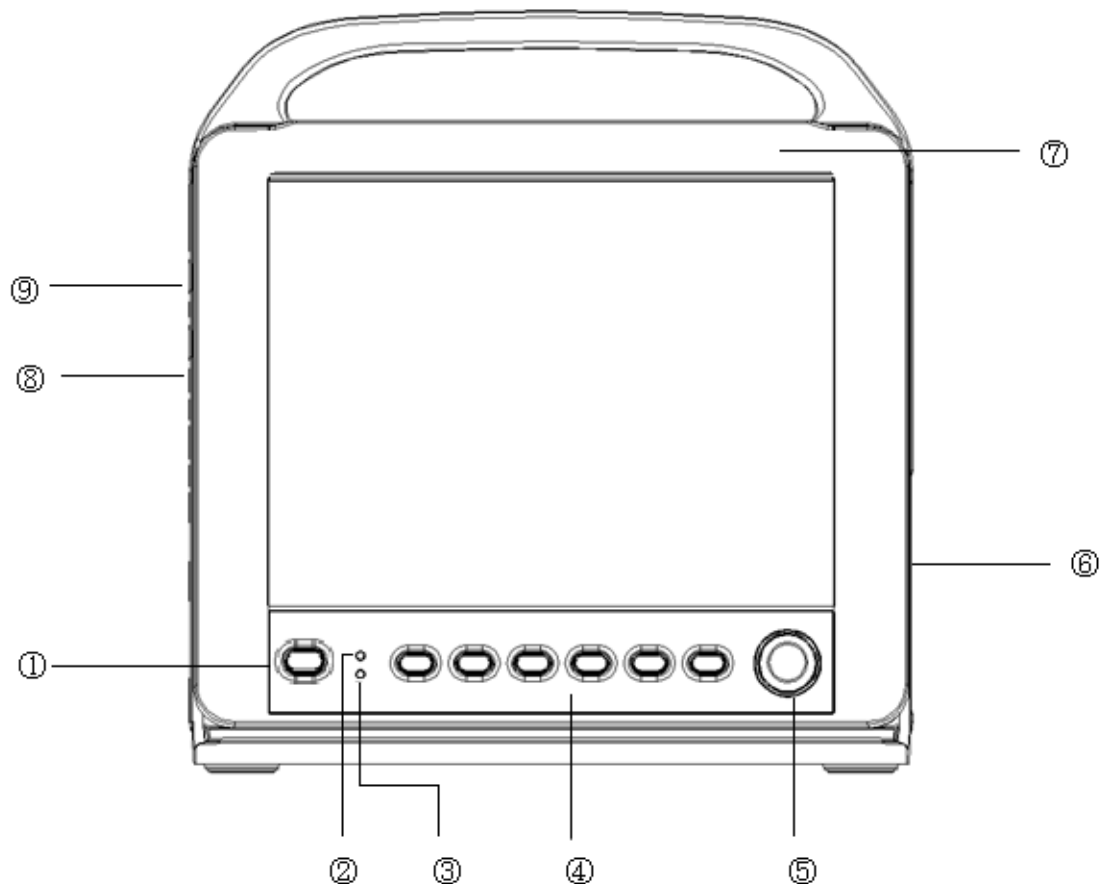

Picture 1-1 Portable Multi-parameter animal Monitor(12 inches)

⚠ Attention ⚠

8 inch, 10 inch, 12 inch and 15 inch monitor parameters and key features are the same

Definition abbreviation:

Items	Definition, abbreviation
ECG	Electrocardiogram
RESP	Respiration
TEMP	Temperature
NIBP	Non-Invasive Blood Pressure
SPO2	Blood oxygen saturation
HR	Heart Rate
RR	Respiration Rate
PR	Pulse Rate

1.2 Display Interface

This equipment is equipped with a color LCD capable of displaying animals' parameter, waveform parameter

collected and alarm information, sickbed No., state of the animal monitor, time, and other prompts provided by the animal monitor at the same time.

Main screen is divided into 4 areas (As shown in picture 1-2,) :

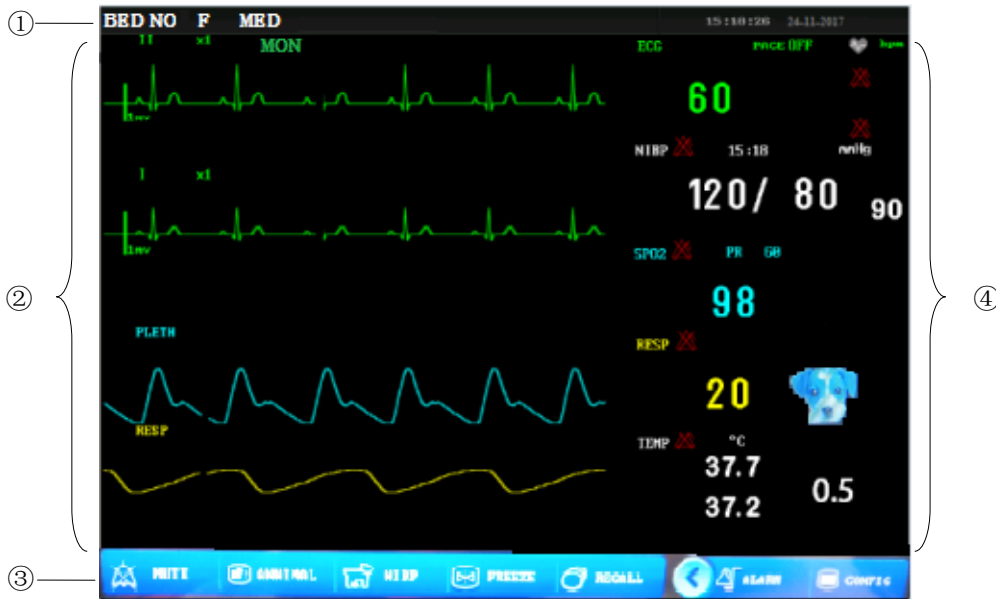

Picture 1-2 Display Main Interface for 12 inches

1. Information area ①
2. Waveform area ②
3. Parameter area ③
4. Touch menu area ④

Information Area(①):

Information area locates at the upper part of the screen displaying the state of the monitor and the animal. Meaning of the information area content is specified as below:

- “BED NO.”: sickbed No. of the animal being monitored
- “F”: Sex of the animal
- “MED”: type of animal being monitored
- “01-07-2016”: current date
- “15:23:40”: current time

Other prompts of the information area are displayed and disappear together with displayed state. According to contents, they are sorted as:

- Prompt of the monitor displays the state of the monitor or sensor appeared always after the area of “MED”;
- Alarm information of the monitor (Refer to chapter of Alarm for detailed setting method.) ;

 is the sign for alarm suspend. When you press this key “ALARM”, it will appear this sign. It indicates that all the alarms are closed temporarily by artificial. The system will re-appear alarm until you press this key “ALARM” or the alarm suspend period over. The alarm suspend time can

be chosen during “one minute”, “two minute”, “three minute”.



is the sign for mute. When you press this key “SILENCE”, it will appear this sign. It indicates that all the sounds are closed by artificial. The system will re-appear sound until you press this key “SILENCE” or there is new alarm in the system.



is the sign for alarm volume close. It indicates sound alarm is permanently closed till the operator changes the setting to sound alarm on.

Attention

When sign  is displayed, there will be no sound alarm given. The operator is required to pay more attention while using this function.

- When waveform on the screen is frozen, the corresponding prompt window of “Freeze” will be displayed at bottom of the screen.
- Alarm information of animals’ parameters is displayed always at the rightmost fixed area of the screen.

Waveform/Menu Area (②):

5 waveforms are displayed in the waveform area. Display sequence of the waveform is adjustable. With the largest configuration, the system may display 3 ECG waveforms, SpO₂ plethysmography waveform, and respiration waveform in the waveform area.

Max. full-screen 6 ECG waveforms may be displayed in the waveform area.

Name of waveform is displayed at top left of each waveform. Cardioelectric lead may be selected according to actual need. Increase of the channel and filtering method of ECG will be displayed on each waveform. There is a 1mv scale at the left side of the ECG waveform. As long as the menu is displayed, it is displayed at the fixed position of center of the waveform area covering part of the waveform temporarily. The original interface will be resumed when exiting from the menu.

Waveform will be refreshed at the set rate. Please refer to setting of parameters for adjustment of waveform refreshing rate.

Parameter Area (③):

Parameter area locates at the right side of the waveform area nearly opposite to waveform. Parameters displayed in the parameter area include:

ECG

—HR or PR (unit: beat/min.)

—ST segment analysis result ST1, ST2 for P1 and P2(unit: mV)

SpO₂

— Blood oxygen saturation (Unit: %)

— PR (unit: beat/min.) (when “Simultaneity” option is chosen for source of HR)

NIBP

- In sequence from left to right lie systolic blood pressure, mean blood pressure and diastolic blood pressure; (unit: mmHg or kPa)

TEMP

- Temperature (unit: °C or °F)

RESP

- Respiration rate (unit: times/min.)

Alarm Indicator and Alarm State:

Alarm indicator does not light up under normal state.

In case of the occurrence of alarm, the alarm indicator flashes or keeps lightening. Color of the indicator represents the alarm level. Refer to the chapter of “Alarm” for detailed information. Please refer to relevant parameters in the related chapters for alarm information and prompts.

Touch menu area (④)

Free to select options by touch screen or knob.



● **MUTE**

Push down this button, you can block all sound (such as alarm sound, heartbeat, pulse, the keyboard sound). And "  " in information area, push down this button again and recover all voice and cancel the



● **PATIENT**

Push down this button to undertake the animal information management, details refer to 3.1

animals information management

● **NIBP**

Press this key to inflate the cuff for blood measuring. During measuring, press this key to stop measuring and to deflate the cuff

● **FREEZE**

Press this key to enter into the state of freeze (The scene keeps still for better observation). Press it again; the system will be active (Scene returns back to state of monitoring).

● **RECALL**

Press this key to start a real time recording.

● **ALARM**



For details, please check Chapter 6 Alarm

● **CONFIG**

For details, please check Chapter 3 System Menu.

1.3 Key functions and Basic Operations

Operations on can be achieved through keys and knobs.

-  Press this key for min. 2 seconds to power On/Off the animal monitor.
-  **SILENCE**
Same function with opinion “MUTE” in touch menu which tunes out the system sounds.

Attention



If new alarm occurs under alarm halt/mute, alarm halt/mute will be automatically resumed. Please refer to alarm chapter for detailed information.

Attention

Alarm resume depends on the existence of alarm factor. But pressing SILINCE key may permanently close alarm sound caused by ECG lead fail and SpO2 sensor fail.

-  **PAUSE**

When you press this key, the alarm time can be as long as 3 minute(“1 minute”、 “2 minute” and “3 minute”can be chosen). In the information area, it will appear

“” . All the alarm can be re-start and the symbol “” can be cancelled if you re-press this key.

Note

The alarm of ECG leads off and SP02 sensor off can be closed if you press key “Alarm” .

-  **FREEZE**

Same function with the opinion “FREEZE” in touch menu.

-  **NIBP**

Same function with the opinion “NIBP” in touch menu.

-  **RECORD**

Same function with the opinion “RECALL” in touch menu.

-  **MENU**

Press this key to pop up “system menu”. Users may set system information in system menu and execute retrospective operation.

- **Rotary Control Knob (Simply the knob)**

Users may rotate this knob to choose menu items and change setting. The knob can be rotated clockwise and counterclockwise, and can be press for operation as well. Users may achieve all operations on main screen, in system menu and parameter menu through this knob.

Screen Operation Performed through the Knob:

The rectangle sign moving along with the rotation of the knob on the screen is named cursor. Operation can be done at the place where the cursor may be positioned. When the cursor is in the waveform area, users may change the current setting. When the cursor is in the parameter area, users may open the relevant parameter menu and set relevant information of parameter.

Operation methods:

- Position cursor at the option to be operated.
- Press the knob.
- System will display one of the 4 below:
 - Menu or measuring window will be popped up on the screen. Or the menu is substituted with a new one.
 - Cursor with grounding will become into a frame without grounding, which means that the content in the frame may be changed along with the rotation of the knob.
 - A sign “√” is displayed at this place indicating this option is selected.
 - Immediately execute a certain function.

1.4 External Interfaces and Plug-in module box

There is a row of standard parameter sensor jack on the monitor to the left, from top to bottom in turn:

ECG cable jack

SpO2 sensor jack

TEMP1 probe jack

TEMP2 probe jack

NIBP jack

Nellcor SpO2 sensor jack

Optional parameters in the parameter module equipped with a plug-in box:

Insert the module: module alignment slot and push in, know the module at the bottom of Pull out the module: press and hold the plug-in box button and outwards pulled the plug box.

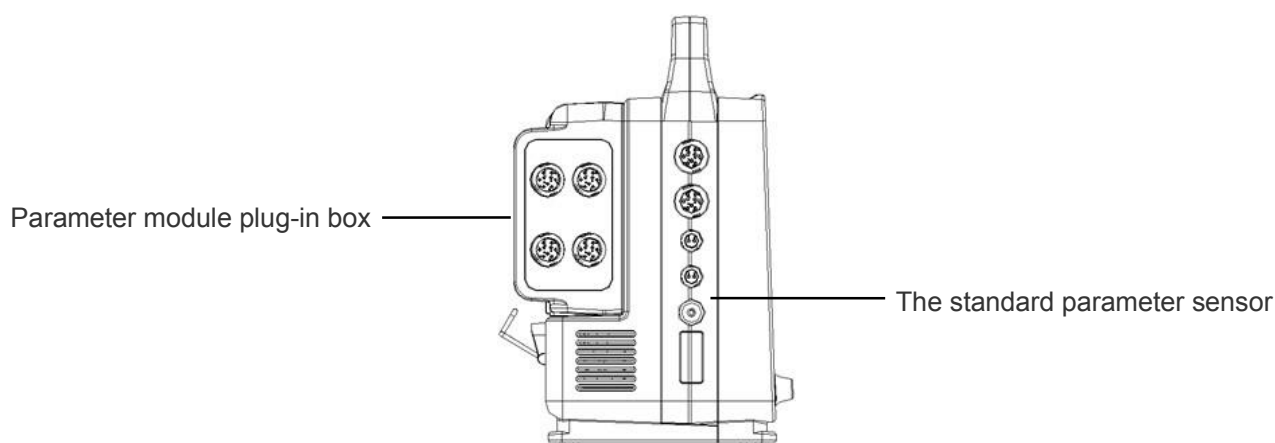

Picture 1—3 Sensor Jack



This sign indicate “Attention”. Refer to the attached document (this manual).



This sign means the applicable component is classified as type of CF. The design is equipped with special protection of anti-electroconvulsive shock (it is equipped with a F type ground disconnecting device particularly in the allowable currency outleakage.) Meanwhile, it is suitable for use during defibrillation.

Other signs are specified in the chapter of animals’ Safety.

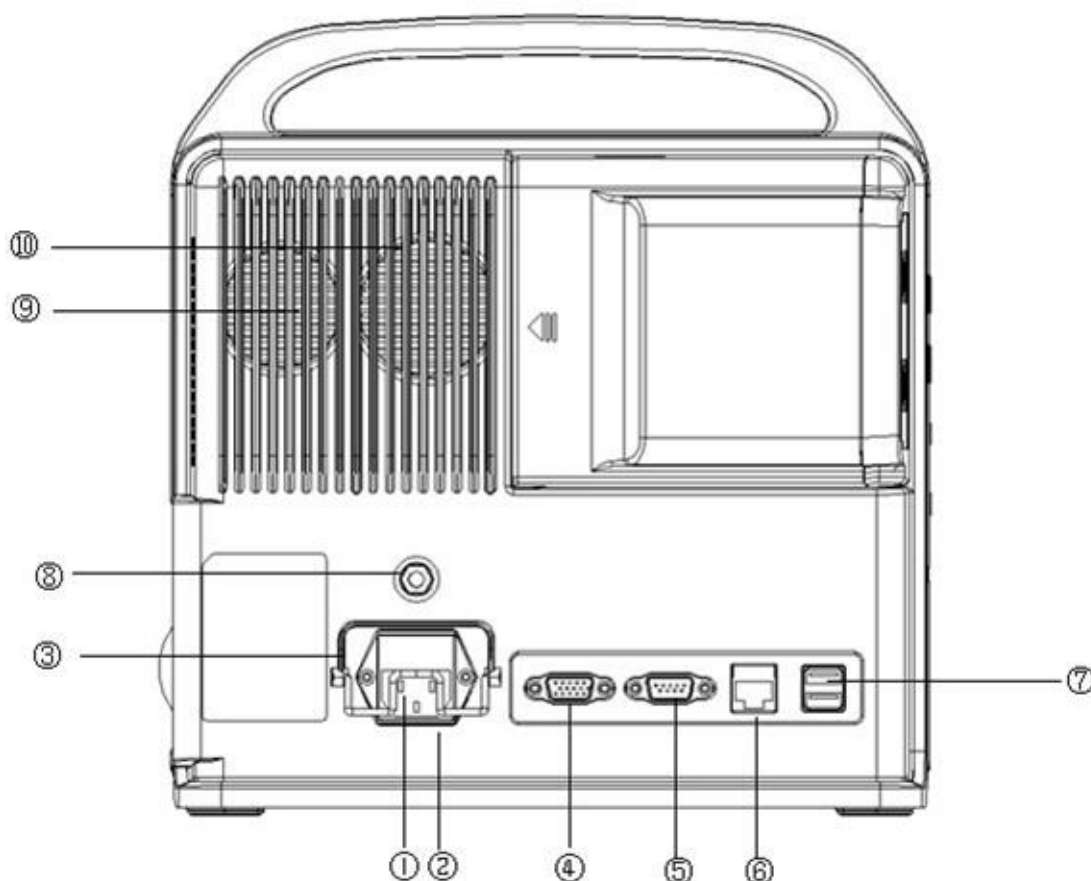

Jacks on back window are shown in picture 1-4

- ① Power plug jack: Output
- ② Fuses jack: Fuses installation
- ③ Plug fixed buckle
- ④ CRT
- ⑤ RS232
- ⑥ Network port
- ⑦ USB connection
- ⑧ Equipotential: Equipotential connection
- ⑨ Built-in loudspeaker(Synchronous heartbeats, Alarm)
- ⑩ Built-in fan

 **Warning** 

All the simulation and digital equipments connected with the animal monitor must be the product having passed appointed IEC standard certification (e.g. IEC 60950 Data Processing Equipment Standard and IEC 60601-1 Medical Device Standard). Moreover, all the configurations must be followed the valid IEC 60601-1-1 system standard. The personnel who are in charge of connecting optional equipments with input/output signal port are to configure the medical system, and are responsible for system's compliance with IEC 60601-1-1 standard. In case of any questions, please contact with the supplier.

1.5 Internal Chargeable Battery

Portable multi-parameter monitor is equipped with an internal chargeable battery. When AC power is supplied, the battery will automatically be charged and charging will not stop until it is charged full.

When the monitor is power supplied by the battery, alarm will be given at low battery. For dead battery, top grade of alarm will be triggered giving continuous sound of toot, and “very low battery” will be displayed in information area. At the time, AC power is required for charging the battery. If the monitor is further power supplied by the battery, automatic shut-off of the monitor will be given before the battery goes dead (about 5 minute after alarming).

Chapter Two Animal Monitor Installation

2.1 Unpacking Inspection

Carefully take out the monitor and the accessories from the packing box. Keep properly the packing material for future transportation and storage. Check the accessories according to the packing list.

- Check if any mechanical damage caused.
- Check all exposed leads, insert part of the accessories.

2.2 Electric Connection

AC power cord connecting steps:

- Make sure that AC power meets the specification of : 100-240VAC, 50 / 60Hz
- Use the attached power cord with the monitor. Insert the power cord into the power interface of the monitor and connect the other end of the power cord with 3-core power socket earthed.



Connect power cord with the unit special socket.



If battery configured, after transportation or storage of the monitor, it is necessary to charge the battery. Therefore, the monitor is not able to work normally due to low battery if a direct startup is performed without AC power supplied. As long as AC power is supplied, the battery will be charged no matter the animal monitor is opened or closed.

2.3 Power On

When powering on, the system will enter into the main monitoring screen after successful self-test about 5 seconds later. At the time, users may perform operation.



If there is function damage found or prompt of error occurred, please do not use the monitor for monitoring animal, and contact the professional biomedical engineer or maintenance technicians of our company.



If vital error is found during self-test, the system will give alarm.



Check all the monitoring functions available to ensure normal function of the monitor.

⚠Attention⚠

If there is a battery configured, battery charging is required after each time of use to ensure sufficient battery reserve.

⚠Attention⚠

Restart the equipment for minimum 1 minute after shut-down of it.

2.4 Connection of Sensor

Connect the required sensor with the monitor and the animal to be monitored.

⚠Attention⚠

Please refer to the related chapters for correct connection and requirements of the sensor.

2.5 Inspection on Recorder

If the monitor is equipped with a recorder, please check if paper is available at the paper outlet on left side of the recorder.

Chapter Three System Menu

- Animals' information management
- Default configuration
- Retrospective function
- Information of monitor
- Setting of monitor
- Maintenance of monitor
- Medicament calculation (no such function available on the monitor)
- Demonstration function

The monitor enjoys a flexible configuration. Content of monitoring and waveform scanning speed can be configured according to users' need. After pressing MENU key on the front window, menu as shown in picture 3-1 will be popped up, and the following operations can be performed:



Picture 3-1 System Menu

3.1 Animals' Information Management



Please refer to “Clear animals’ data recorded” in this chapter for clearing current animals’ data.

Select “patients’ information management” in Touch menu area, the menu as shown in picture 3-2 will be popped up.



Picture 3-2 Animal's Information Management

- BED NO. 1-200 optional
- SEX Sex of the animal
- PAT TYPE Type of animal(Large animal, medium animal, small animal)
- PACE The animal is with a pacemaker or not. If yes, please select On.(If yes, there will be a row of dots displayed in the ECG waveform area.)
- NEW animal Monitor a new animal, but will not delete the monitoring data of the previous animal. In this menu, users may also select the option of “Refreshing animal” to enter into a dialog box of “Confirm refreshing animal” to determine if to clear data. As shown in picture 3-3:

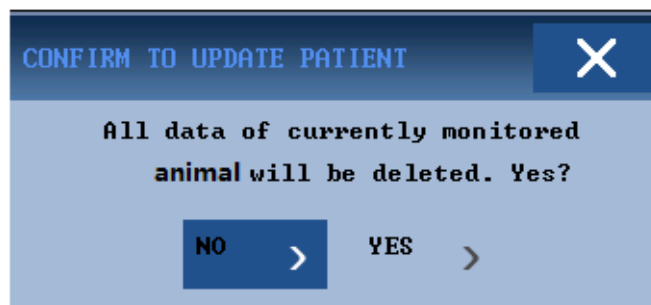

Picture 3-3 Confirm Refreshing animals' Data

Select “Yes” to delete all the information of the animal being monitored and exit menu.
 Select “No” to save the information of the animal and exit menu.

⚠Attention⚠

Selection of “Yes” will delete all the information of the animal monitored.

3.2 Default Configuration

Users may set current system configuration as users' default configuration. At the time, the system will automatically save all the current parameter menu setting, ECG lead, increase and filtering as the corresponding type user default configuration content according to the type of animal, and a dialog box as shown in picture 3-4 will be popped up:

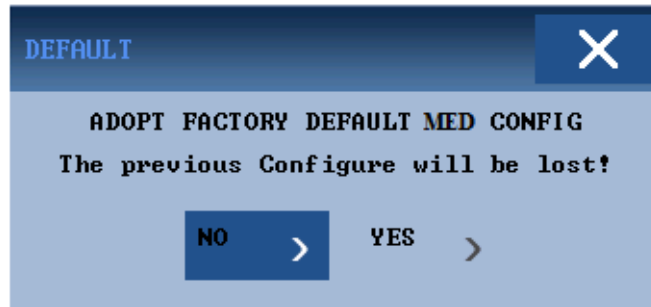

Picture 3-4 Default configuration Menu

Select “Yes” to save all the configurations of the current animal as user default configuration.

Select “No” to delete the current operation. The system will keep the original configuration unchanged.

3.3 Retrospective Function

When selecting “Retrospective function” in “System menu”, the menu as shown in picture 3-5 will be popped up.

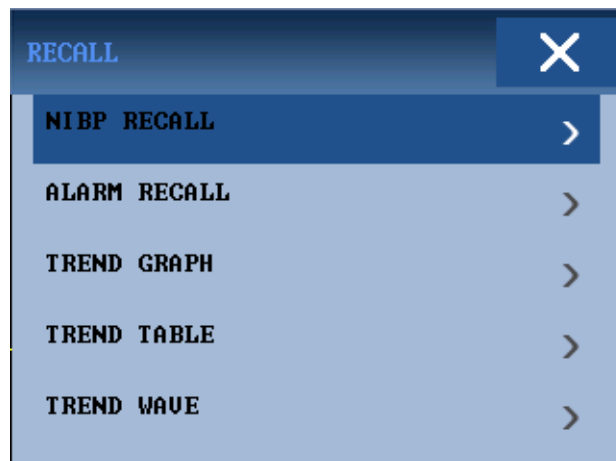

Picture 3—5 Retrospective Function menu

When selecting “Retrospection of NIBP measurement” in “Retrospective function”, the menu as shown in picture 3-6 will be popped up:

3.3.1 Retrospection of NIBP

The monitor can display the latest 400 NIBP measurement data in NIBP retrospection.

When selecting “Retrospection of NIBP measurement” in “System menu”, the last 3 times of NIBP measuring result and measuring time will be displayed in the window.

	NS	NM	ND	TIME	
1.	120	90	80	06-29-2016	16:52:01
2.	120	90	80	06-29-2016	16:26:52
3.	120	90	80	06-29-2016	16:14:37
4.	120	90	80	04-08-2016	14:31:40
5.	120	90	80	04-08-2016	14:29:59
6.	120	90	80	04-08-2016	14:02:26
7.	120	90	80	04-08-2016	14:02:02
8.	120	90	80	04-08-2016	13:59:37
9.	120	90	80	03-30-2016	14:19:45
10.	120	90	80	03-30-2016	13:01:45

NUM: 400 UNIT mmHg > UP > DOWN > REC >

Picture 3—6 Retrospection of NIBP measurement

Data are arranged in sequence of measuring time beginning from the last time. Each screen may display 10 times of measured data. Select “Page down/up” to the earlier or later measured data. Max. 400 times of measuring result can be displayed. When measurement exceeds 400 times, the last 400 times of data will be displayed.

3.3.2 Retrospection of alarm event

“Alarm events retrospection” recorded the alarm information of a certain time. The user can click “UP-DOWN” to view .

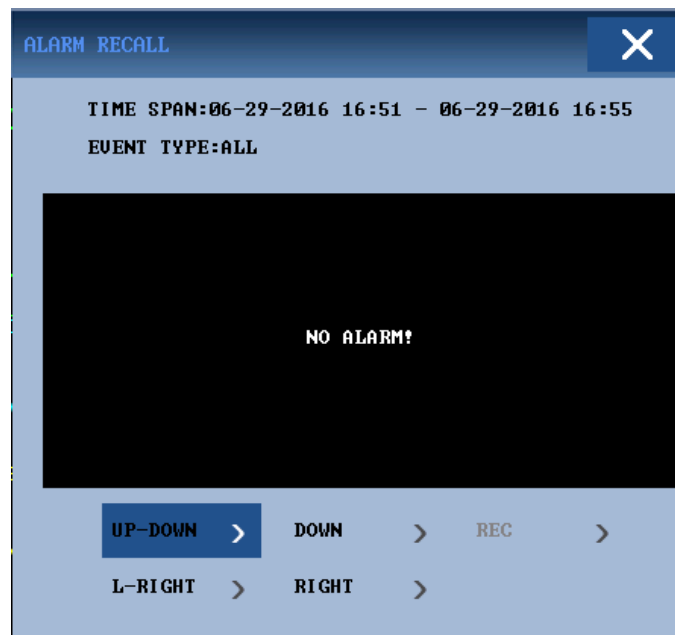

Picture 3-7 ALARM RECALL

3.3.3 Retrospection of trend plot:

- The last 1 hour's trend plot can be displayed at the data resolution of 1/second or 5/second.
- The last 96 hours' trend plot can be displayed at resolution of one datum for every 1 minute, 5 minutes or 10 minutes.

When selecting “Retrospection of trend plot” in “System menu”, the following window will be popped up.

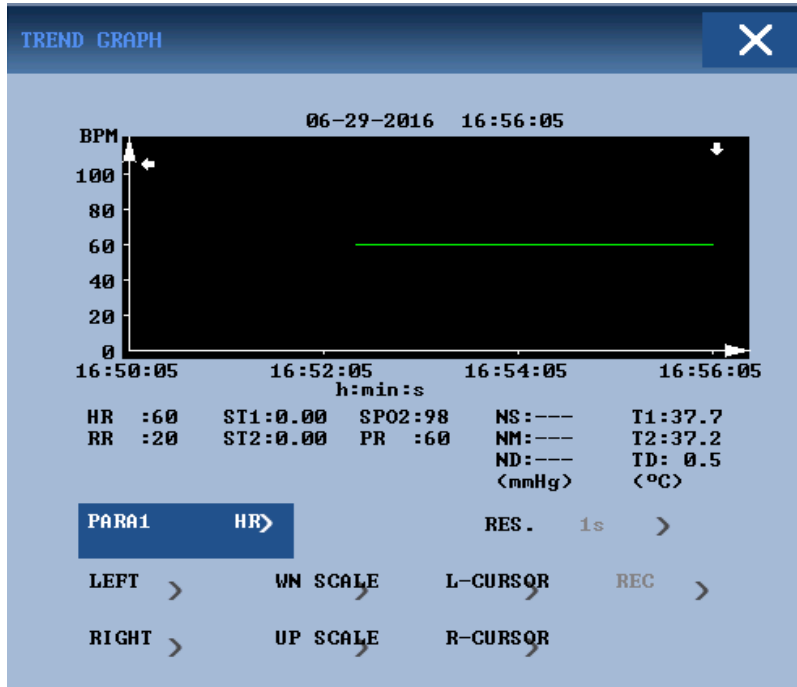

Picture 3-8 Trend Plot Menu

Vertical ordinate indicates the measuring value, while the horizontal ordinate indicates the measuring time. “↓” is the cursor of the trend plot. The measuring value of the position indicated by “↓” will be displayed at the lower part of the trend plot, and the corresponding time will be displayed at the upper part of the trend plot. With the exception of NIBP value, other trends will be displayed in way of continuous curves. In the NIBP trend plot, “S” represents systolic blood pressure; “D” represents diastolic blood pressure; “M” represents mean blood pressure.

Select trend plot display with different parameter:

Select the option of “Parameter selection” with cursor to modify the displayed content. When the desired parameter appears, press the knob.

The trend plot of this parameter is displayed in window.

Select 1-hour or 96-hour trend plot:

Select the option of “Resolution” with cursor. Select 1 second or 5 seconds, if 1-hour trend is desired to be observed. Select 1 minute, 5 minutes or 10 minutes, if 96-hour trend is desired to be observed.

Observe earlier or nearer trend curve:

If there is an instruction of “→” at the right side of the window, press “Left and right moving” key, turn the knob clockwise to observe the nearer trend curve; if there is an instruction of “←” at the left side of the window, press “Left and right moving” key, turn the knob counterclockwise to observe the earlier trend curve;

Modify display proportion

The proportion of vertical ordinate can be changed through “Amplitude adjustment” key, and proportion of the trend curve will then be changed accordingly. The value heater than the max. coordinate value is represented with the max. value.

Get the certain moment trend data from the current trend plot

Select “Moving cursor” and turn the knob leftward or rightward, the cursor then will move along with it, the period of time indicated by it will also change accordingly. The parameter value for this moment will be displayed under the horizontal ordinate. If there is an instruction of “→” at the right side of the window, when the cursor moves to this position, page down/up of the trend plot will be automatically performed to display the nearer trend curve; if there is an instruction of “←” at the left side of the window, when the cursor moves to this position, page down/up of the trend plot will be automatically performed to display the earlier trend curve.

Example of operation

To observe NIBP trend plot for the last 1-hour:

- Press MENU key on the control window, “System menu” will be popped up;
- Select “Figure retrospection” in the menu, and then select “Retrospection of trend plot”;
- Select parameter: Turn the knob in the option of “Parameter selection” till “NIBP” appears in the box;
- Select “1 second” or “5 seconds” in the options of “Resolution”;
- Select “Left and right moving”, turn the knob, observe the time changes of trend plot and the changes of trend curve;
- Stop at the time section needed for careful observation. If there is improper proportion of the vertical ordinate, such as, partial trend value exceeds the current vertical ordinate max. value, select “Amplitude adjustment” for adjusting;
- For knowing the measuring value of a certain moment, select “Moving cursor” and move the cursor to this place. Time will be displayed at the upper part and the measuring value will be displayed at the lower part;
- Press “Exist” key to exit observation of trend plot.

3.3.4 Retrospection of trend table

- The trend table data of the last 96-hour can be displayed at the resolution of: 1 minute, 5 minutes, 10 minutes, 30 minutes, 60 minutes.

After selecting “Retrospection of trend table” in “System menu”, the following trend table will be popped up:



Picture 3-9 Trend Table setting Menu

The corresponding time for each group of trend data will be displayed at the left-most line. Those in the bracket are dates. Those listed under Event are marked events corresponding to the time of mark events. Parameters in trend table can be sorted into 8 groups:



HR, PVC; RR; ST1, ST2; T1, TD T2; SP0₂, PR; NIBP S / M / D.

The display of NIBP trend data is of its particularity. Except for measuring value, NIBP measuring time will also be displayed under “Measuring point”. If there are more measuring values, only one group are to be displayed. Meanwhile, “*” will be displayed at the position of “MORE” meaning that there are two or more times of measuring result.

Select trend table at different resolutions:

Select resolution with cursor, change the options with the knob, change time interval of the trend data.

Observe earlier or nearer trend curve:

If there is an instruction of  above the window, “Page down/up” may be selected, turn the knob clockwise to observe the nearer trend data; if there is an instruction of  under the window, “Page down/up” may be selected, turn the knob clockwise to observe the earlier trend data;

Observe trend data with different parameters

Select “Left and right moving”. Any one group of the six groups can be chosen. At the right side of the right-most parameter there marked a mark of “>” indicating that page can be turned over rightward; at the left side of the left-most parameter there marked a mark of “<” indicating that page can be turned over leftward.

Operation example

Observe NIBP trend table:

- Press MENU key on the control window, “System menu” will be popped up;
- Select the option of “Retrospection of trend table” in the menu;
- Select parameter: Select” Left and right moving”, turn the knob till NIBP data appear in the window;
- Select resolution: select the option at the left side, select the desired time interval;
- Select ” Page down/up”, turn the knob, observe NIBP trend data at different time;
- Press “Exit” key to exit observation of trend table.

3.3.5 Retrospection of trend wave

“The waveform retrospection” recorded the monitoring information of a certain time interval, Users can choose to display in the waveform and waveform component of the waveform parameters, click up-down or cursor to view page, as shown in figure 3-10.

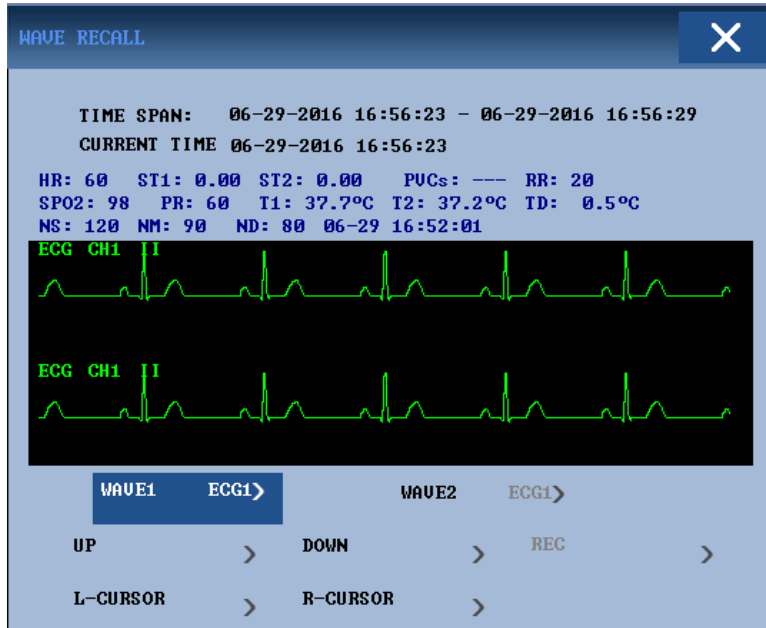

Picture 3-10 Trend wave setting Menu

3.4 Information of Monitor

“Information of monitor” may be selected in the “System menu” for the information of the monitor, as shown in picture 3-11.

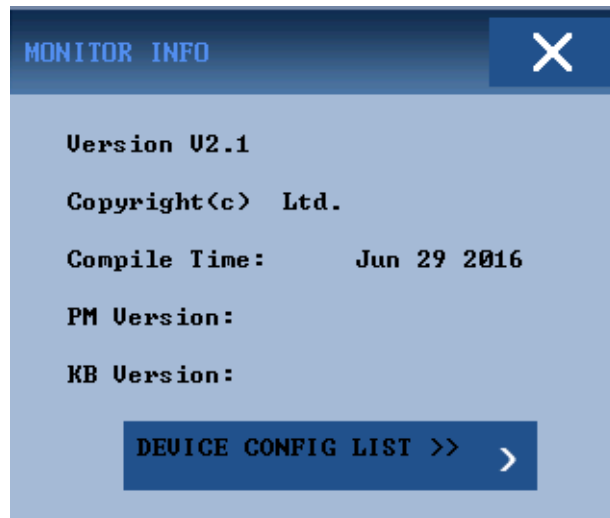

Picture 3-11 Machine Version

3.5 Setting Monitor

Select “Setting of monitor” in “System menu”, the menu as shown in the picture 3-12 will be displayed:

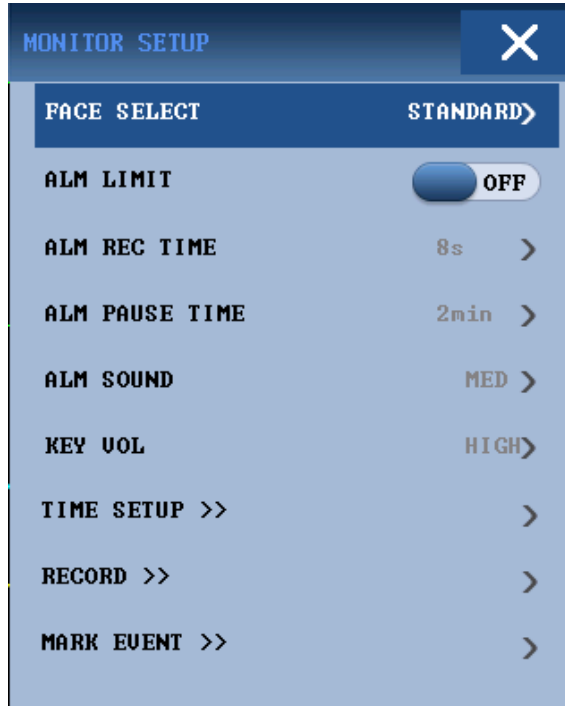

Picture 3-12 Monitor setting

In the menu of “monitor setting”, users may set the following items:

3.5.1 Work Interface Selection

Select the option of “Work interface selection” in the menu of “Setting of monitor”, you may see that the current option is standard inter face.

3.5.2 Alarm limit display

Select “Alarm limit display” in the menu of “Setting of monitor”. Two states of “Off” and “On” are optional. When “On” is selected, limit value of alarm will be displayed in the data display area of parameter. Whereas, when state of “Off” is selected, limit for alarm will not be displayed.

3.5.3 Alarm recording time

Select “Alarm recording time” in the menu of “Setting of monitor”, turn the knob to set recording output time while alarming. There are options of “8 seconds”, “16 seconds” and “32 seconds” available.

3.5.4 Alarm pause time

Select “Alarm pause time” in the menu of “Setting of monitor”, turn the knob to set time of break. During this period of time, the system will not deal with any alarm. There are options of “1 minute”, “2 minutes” and “3 minutes” available for timeout.

3.5.5 Alarm sound setting

Select “Alarm volume setting” in “System menu”, turn the knob to set alarm volume size, optional items are "low", "middle" and "high".

3.5.6 Key volume setting

Select “Key volume setting” in “System menu”,turn the knob to set key volume size, optional items are "off", "low", "middle" and "high".

3.5.7 System Time Setting

After selecting the option of “System time setting” in the menu of Setting of monitor”, the menu as shown in picture 3-13 will be popped up:

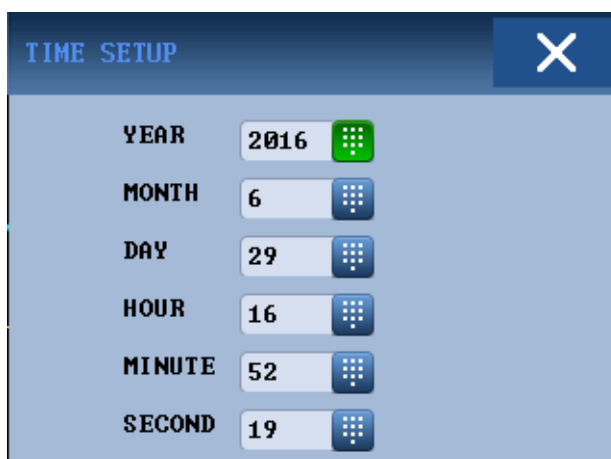

Picture 3-13 System Time Setting

3.5.8 Record output setting

Select “REC SETUP” in the menu of “Record Output Setting”, the menu as shown in picture 3-14 will be popped up.



Picture 3-14 Record Setup

Printing contents of the record wave1 and record wave2 are modifiable. ECG1,ECG2,SPO2,RESP waveforms are supported to print.

3.5.9 Event Setting

Select “REC SETUP” in the menu of “MONITOR SETUP”, the menu as shown in picture 3-15 will be popped up.

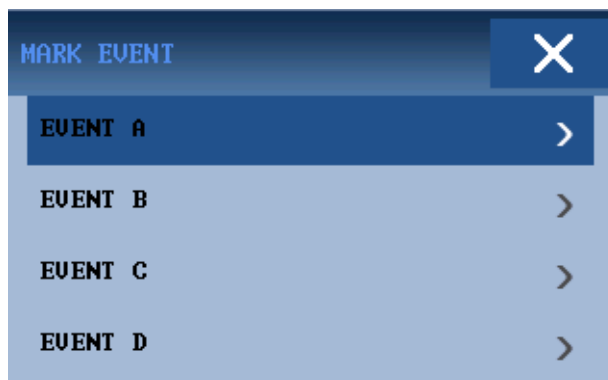

Picture 3-15 mark event Setup

Users can define four events by themselves, namely the events A, B, C and D, and can choose the corresponding event in this menu. For the chosen event, a sign "@" will appear in the event box, choose again will cancel the mark event. The meaning of the mark event is to define various situations related to animals and will have influence on the parameter monitoring, such as taking and injecting drugs, various treatment, etc., and the time will be displayed on the trend table/graph in order to help analyze animals' parameters at the incident moment.

3.6 Maintenance of monitor

Select the option of “Maintenance of monitor” in “System menu”, dialog box of “Enter maintenance password” will be popped up as shown in picture 3-16.

Users may perform maintenance in user maintenance menu by entering user password. Users can not perform factory maintenance function. This option is only accessible for the appointed maintenance personnel by our company.

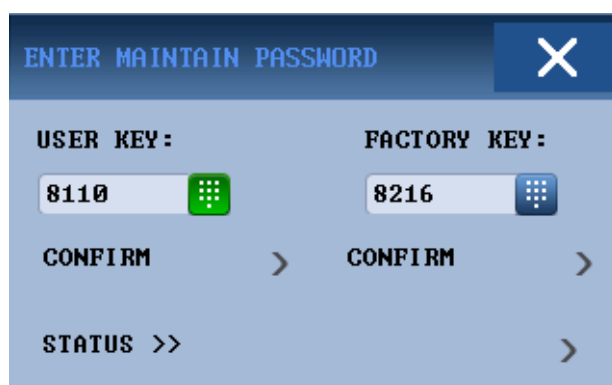

Picture 3-16 Enter Maintenance Password

3.7 Demonstration Function

After selecting “Demonstration function” in “System menu”, the dialog box of “Enter demonstration password”

will be popped up. When correct password is entered, the system enters into demonstrating waveform state. Demonstration waveform is the simulation demonstration waveform set by the manufacturer for showing machine performance and assisting users in training. In actual clinical use, the function of waveform demonstration is prohibited, because it may have the medical personnel mistake it as the animal's waveform and parameter being monitored, and thus monitor on animal affected and treatment delayed. For this reason, a password is equipped with this menu, as shown in picture 3-17.

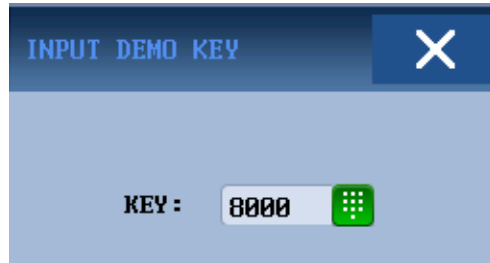

Picture 3-17 Demonstration Function

Chapter Four Animals' Safety

The design of the portable monitor meets the requirements per relevant international standards of IEC60601-1, EN60601-2-27 and EN60601-2-30 constituted for medical electric equipments. This system is equipped with protection of ground disconnecting input anti-defibrillation and surgical electric knife. If adopting correct pole (refer to chapter of ECG and RESP) and mount it according to the guidance of the manufacturer, screen display may be resumed 10 seconds later after defibrillation.



This sign indicates that the component is an IEC 60601-1 type CF equipment. Its design is of special anti-shock protection (It is equipped with F type ground disconnecting isolation device particularly in allowable currency leakage.) and is suitable for use during defibrillation.



Keep away from animal, sickbed prequipment during defibrillation.

Environment:

For ensuring the safety of the electric installation, please follow the following guidance's. Use environment of the portable monitor should reasonably be free of vibration, dust, corrosive or explosive gas, extreme temperature and humidity, etc. When installed in a cabinet, enough room should be kept at front for convenience of operation. When the door of the cabinet is opened, there should be kept enough room at back for maintenance. Good ventilation should be kept in the cabinet.

Monitoring system may satisfy technical index under the environmental temperature ranging 0°C~40°C. If environmental temperature exceeds such a range, it may affect the accuracy of the equipment or component or circuit damage caused in. Min. 2 inches (5 centimeter) of interspaces should be kept around the equipment for good ventilation.

Requirement for power supply

Please refer to the chapter of Product Specification.

Earthing of the portable monitor

To protect animal and medical personnel, the portable animal monitor must be securely earthed. The portable animal monitor is equipped with a removable 3-core cable. When it is inserted into a matching 3-core socket, it is earthed through earthing cable of the power cord. If there is not 30core socket available, please consult the hospital electric technicians.



Connecting the 3-core cable of the equipment with 2-core socket is prohibited.

Connect the earthing cable with equal electric potential terminal. If you are not sure that a certain equipment combination is dangerous or not from the specification of the equipment (e.g. danger caused by accumulation of the leakage currency), you should consult the manufacturer or expert to ensure that the necessary security of the equipment will not be destroyed by the recommended combination.

Equal electric potential earthing

The first grade protection of the equipment is included in the system of house protective earthing by way of earthing of power socket. For internal check of heart or brain, the portable monitor must be connected with equal electric potential earthing system separately. One end of the equal electric potential (electric equalization lead) is connected to the equal electric potential earthing terminal on the back window of the equipment, and the other end is connected to another terminal of the equal electric potential system. In case of protective earthing system damaged, equal electric potential system may undertake the protective function of protective earthing lead. Heart (or brain) check can only be performed in the medical use room equipped with protective earthing system. Before use, it is required to check if the equipment is in good work state. Cable used for linking animal with the equipment must be free of electrolyte pollution.



If protective earthing system is unstable, the monitor should be power supplied by internal battery.

Condensation :During working, the equipment must be kept free of condensation. When the equipment is moved from one room to another, condensation may be caused in. It is because the equipment has been exposed to humidity air and different temperatures.









Using in the place with inflammable anesthetic risks explosion.

Interpretation for the signs used on the monitor

Symbol	Description	Symbol	Description
	Serial number		Manufacturing date
	Type CF defibrillation proof applied parts		Manufacturer
	Equal electric potential earthing end		Recycled separately from other household waste under the WEEE directive
	Consult instructions for use	IP22	Waterproof grade 2 according to IEC60529

User Manual for Multi-parameter Veterinary Monitor

	The symbol means dangerous voltage		Cautions, please refer to attached documents
	Keep dry		Up toward
	Keep away from sunlight		Humidity range
	Temperature range		

Chapter Five Maintenance and Cleaning

5.1 Maintenance and Test

Before using this equipment, it is required to test:

- mechanical damage;
- all the exposed lead, insert and accessories;
- all equipment functions used to monitor animal, and ensure the equipment in good work state.

In case of any evidence found to indicate the damage of the equipment function, it is prohibited to use this equipment to monitor animal. Please contact the hospital biomedical engineer or maintenance technicians of our company.

Comprehensive functional test including security test must be performed once for every 6-12 months by qualified personnel and after each maintenance.



If veterinary clinic or research units using the equipment have not a satisfied maintenance scheme available, failure of the equipment may be caused in and that may endanger health.

5.2 General cleaning

Caution: It is required to power off and disconnect power supply before cleaning this equipment and sensor.

This equipment must be placed in dust-free environment.

It is recommended to clean the casing surface and screen of display. Use non-corrosive cleanser, like soap and clear water.

- Do not use strong solvent, like acetone.
- Be careful not to damage the monitor.
- Only after dilution can most of the cleansers be used. Please follow manufacturer's instruction to dilute the cleansers.
- Wear materials are strictly prohibited (for example, steel wool or silver polishing agent).
- Prevent any kind of liquid from entering into the casing. Immersion in liquid of any part of the system is strictly prohibited.
- Do not remain any cleaning liquid on surface of the equipment.

5.3 Application of Cleanser

Except the solutions listed under "Caution", any solutions classified as the product with following properties can be used as cleanser:

- diluted ammonia
- diluted Sodium Hypochlorite (bleaching powder for washing)

Concentration range is from about 500ppm (1:100 diluted home use bleaching powder) sodium hypochlorite to 5000ppm (1:10 diluted home use bleaching powder), which is very effective. The amount of ppm depends on the amount of organic matter (blood, animal and plant mucilage) on the surface to be cleaned and disinfected.

- 35~37% diluted formaldehyde 35~37%
- Hydrogen Peroxide 3%
- ethanol
- isopropanol

Surface of the monitor and sensor may be cleaned with medical alcohol and dry it by natural wind or with clean and dry cloth.

Our company undertakes no liability for the effectiveness of the chemical products used for controlling infectious diseases. Please consult your hospital infection control principal or experts on infectious disease.

5.4 Disinfection and Sterilization

For avoiding long term damage against the equipment, product sterilization is recommended to be performed only when it is necessary in the hospital maintenance scheme. Cleaning is also recommended for the product to be sterilized.

Recommended sterilization materials: ethanol, aldehyde

Caution

- **Follow manufacturer's instruction for dilution or adopt the lowest concentration possible.**
- **Keep liquid away from entering into the casing.**
- **Immersion of any part of the system is strictly prohibited.**
- **During sterilization, do not pour the liquid onto the system.**
- **Do not remain germicide on surface of the equipment. Please use a wet cloth to clean the leftover (if any).**

5.5 Disinfection

For avoiding long term damage against the equipment, product sterilization is recommended to be performed only when it is necessary in the hospital maintenance scheme. Cleaning is also recommended for the product to be sterilized.

As for ECG lead, SpO2 sensor, blood pressure cuff, temperature probe, please refer to the content in related chapters.

Caution

Be careful not to damage the monitor. Do not disinfect the monitor with EtO or formaldehyde.

Chapter Six Alarm

- This chapter will introduce the general information concerning alarm and measures to be taken in case of alarm.
- Refer to the contents in related chapters involving parameter setting for the information of each parameter alarm and prompt.

6.1 General Introduction to alarm

The so-called alarm indicates the prompt sent by the monitor to the user when changes of vital signs of the animal being monitored are so important to arouse attention or failing in animal monitoring due to faults of the equipment.

6.2 Alarm Property

6.2.1 Type of Alarm

There are two types of alarm: If the alarm is caused by the changes of animal's vital signs, namely the physiological parameters of the animal being monitored exceeds the specified range or the animal is with physiological abnormality unable to be measured by overrun of a single physiological parameter, the alarm is named as physiological alarm; if the alarm is caused by the equipment, namely the alarm is caused by technical obstacles in using the animal monitor or failure of the equipment causing inaccurate monitor on the animal, the alarm is named as technical alarm.

6-1 Examples of Physiological Alarms and Technical Alarms

Description	Type of alarm
The measured HR of animal is at 114BPM, which exceeds HR alarm range set by user.	Physiological alarm
Ventricular fibrillation is found on animal.	Physiological alarm
ECG measurement module detects fail of ECG lead.	Technical alarm
SpO2 measurement module is out of order.	Technical alarm

6.2.1.1 Classification of Physiological Alarms

There are two kinds of physiological alarms. One of them is that physiological parameters of the animal being monitored exceeds the specified range, while the other is that physiological abnormality of the animal is unable to be measured by overrun of a single physiological parameter.

The latter belongs to the alarm which can screen the former. They are:

- too weak of the ECG signal;
 - cardiac arrest; ventricular fibrillation/ventricular tachycardia;
 - no pulse found;
 - RESP cardiac interference;
 - RESP asphyxia;
- Others belong to the former kind.

6.2.1.2 Alarm Level

Both technical alarm and physiological alarm have a level characteristic. The higher alarm level, the more watchful way of the alarm prompt given by the system. All technical alarm levels can not be changed by users. Some of the physiological alarm levels can be set by users, while some of them are not permitted to changes after being designated by the system.

6.2.1.3 Removable Sound and Light

”Sound and light removable” indicates some technical alarms are changed to the prompt way of prompt, if operation pause is performed, no matter in timeout state or resumed to normal alarm state, the details are as below:

1. The capability driving sound and light alarm is removed, namely, no sound and light alarm performed.
2. The capability driving character is removed, namely, the color of under color will be changed to the same color as title under color.
3. After normal alarm state resumed, when this alarm is triggered, alarm is notified in way of normal alarm.

This kind of technical alarm is caused mainly by errors of lead fail in technical alarm, other errors beyond NIBP parameter alarm limit and normal use obstacle of the recorder.

6.2.1.4 Removing All

Removing all: press SILENCE key for pause state, this alarm may be removed, that is no more alarm prompt given; in pause state, this alarm will not be performed; when pause is terminated, alarm will not be performed until this alarm is re-triggered. Mainly are the communication errors in technical alarm and errors of module initialization.

6.3 Alarm Prompt Method

In case of alarm, sound and light, character prompts will be given.

6.3.1 Sound and Light Property

6-2 Sound and light properties for different levels of alarm

Alarm Level	Alarm Sound Properties	Alarm Light Properties
High	Mode: toot-toot-toot-----toot-toot, toot-toot-toot-----toot-toot; the alarm sound is given once for every 11 seconds (Interval counts from the beginning of this time to the beginning of next time.)	Alarm indicator flashes in red color and high frequency.
Middle	Mode: toot-toot-toot; the alarm sound is given once for every 25 seconds (Interval counts from the beginning of this time to the beginning of next time.)	Alarm indicator flashes in yellow color and low frequency.
Low	Mode: toot-; the alarm sound is given once for every 25 seconds (Interval counts from the beginning of this	Alarm indicator keeps lighting in yellow.

	time to the beginning of next time.)	
--	--------------------------------------	--

6.3.2 Character property

Under color: red color is for high level of alarm, yellow color is for middle and low level of alarms.

Color of character string: Except prompt area of NIBP technical alarm, without reference to alarm level, is always black. Character string color displayed in NIBP technical alarm prompt area has nothing to do with level of alarm. High alarm is displayed in red color, middle and low level of alarms are displayed on yellow. When physiological alarm is caused by alarm exceedance of measuring parameter, the parameter value will trigger the alarm flashes. Sing of “***” displayed in the information area at top right of the screen indicates the occurrence of alarm, its color is red. If it is a technical alarm, there is no prompt sign of “*” displayed in the information area.

6.3.3 Others

If various levels of alarm occur at the same time, sound and light prompt will be given by the highest level of the current alarms.

6.4 Alarm State

6.4.1 General Introduction to Alarm State

Each alarm has two states: triggering state and removing state. Only one state is available for the same period of time.

Triggering state: state of alarm existence

Removing state: state of alarm inexistence

At the beginning of work, all possible alarms are in the removing state. Afterwards, when alarm conditions are to be satisfied, alarm enters into triggering state.

The whole alarm system (all alarms) has the following states:

1. Normal state: alarm is in triggering state and able to give all prompts (including sound, light and character).
2. Alarm timeout state: alarm is in triggering state, but temporarily gives no sound, light and character prompt.
3. Alarm mute state: alarm is in triggering state giving light and character prompt, but gives no sound prompt.
4. Alarm sound closedown state: alarm volume is at 0.

Only one state is available for the whole alarm system at the same period of time.

6.4.2 Alarm Mute State

Alarm mute state means that all sounds (including sounds of alarm, key and pulse) of the monitor are closed down.

6.4.3 Alarm Sound Closedown State

Alarm sound closedown state means that all other sounds are not closed down with the exception of sound of alarm prompt.

6.4.4 Alarm Timeout State

During alarm timeout, the followings may be dealt with:

Refuse sound and light prompts for all alarms.

Refuse character prompt for all physiological alarms.

The left time for alarm timeout is displayed in physiological alarm description area.

Changing alarm prompt of sound and light removable alarm to prompt.

Removing alarm prompt of complete removable alarm.

6.4.5 State Switch-over

In normal state:

1. Short press SILENCE key (< 2s) to enter into alarm timeout state; long press PAUSE/SILENCE key (>= 2s) to enter into alarm mute state.

In alarm timeout state:

2. Short press SILENCE key (< 2s) to enter into normal state; long press SILENCE key (>= 2s) to enter into alarm mute state.
3. If no pressing key during timeout, enters into normal state.
4. During timeout, if there are new alarms, alarm timeout state will be ended, enters into normal state.
5. During timeout, if there are new physiological alarms, the system will be still in alarm timeout state.

In alarm mute state:

1. The current alarm mute state will be ended to enter into normal state in case of occurrence of either new technical alarms or new physiological alarms.
2. Short press SILENCE key (< 2s) to enter into timeout state; long press SILENCE key (>= 2s) to enter into normal state.

In any states:

1. In user setting, setting alarm sound to Off, the system enters into alarm off state.
2. In user setting, setting alarm sound to On, the system enters into alarm on state.

6.5 Alarm Method

6.5.1 General Introduction

There are two alarm methods: latch-up and latch-out.

Latch-up: when alarm conditions are inexistent, the property that the system still gives this alarm prompt is called latch-up method. Only after resetting the alarm system can inexistent alarm not be notified.

Latch-out: when alarm conditions are inexistent, the property that the system gives no alarm prompt is called latch-out method.

6.5.2 Scope of Application

All physiological alarms may work in latch-up method.

All technical alarms can work only in latch-out method.

6.5.3 Latch-up Alarm Prompt

When an alarm is latched up (meaning that this alarm happened, but the alarm was not in triggering state), prompt methods of this alarm will have the following changes:

1. Measuring parameters and relevant alarm limit stop flashing.

2. After prompt lemma of alarm description, there is the system time for entering last time triggering state.

6.5.4 Removing Latch-up Method

Removing latch-up method is also names as alarm reset. Users may use alarm timeout function to reset alarm. When alarm latch-up is removed, the alarms those happened and with inexistent alarm conditions due to latch-up method yet give still alarm prompts will be removed.

When it is working under latch-out method, alarm timeout key on keyboard module has only timeout function but without function of reset.

6.6 Alarm Setting

Select “alarm” in Touch menu area, alarm setting of each parameter module is displayed as shown in picture 6-1.



Picture 6-1 Alarm Setting

Alarm Setting of Measuring Parameters

- ST: Set upper and lower limit for ST, alarm will be triggered beyond the limit.
- ECG: Set upper and lower limit for ECG, alarm will be triggered beyond the limit.
- SYS: Set upper and lower limit for SYS, alarm will be triggered beyond the limit.
- MAP: Set upper and lower limit for MAP, alarm will be triggered beyond the limit.
- DIA: Set upper and lower limit for DIA, alarm will be triggered beyond the limit.
- SPO2: Set upper and lower limit for SPO2, alarm will be triggered beyond the limit.
- PR: Set upper and lower limit for PR, alarm will be triggered beyond the limit.
- RESP: Set upper and lower limit for RESP, alarm will be triggered beyond the limit.
- T1 and T2: Set upper and lower limit for T1 and T2, alarm will be triggered beyond the limit.
- TD: Set upper and lower limit for TD.

6.6.1 Sound On/Off Setting

Refer to the description for alarm sound on/off in maintenance of animal monitor of system setting.

6.6.2 Automatic Alarm Closedown

Automatic alarm closedown means the invalidation of the whole alarm function. At the time, even under the condition that alarm conditions are satisfied, the system will give no alarm prompt, alarm printing and alarm storing.

When there is a new measuring module joining in or at the beginning of work of a measurement module, within 30 seconds counting from working start of the module, all alarms in relation to this module will be automatically closed down, while other alarms will not be affected.

6.6.3 Power-on Lead fail

At power-on, if parameter module opened has not lead, the followings will be dealt with:

1. As for ECG or SPO2 module, change alarm prompt of lead fail to prompt (that is sound and light are automatically removed), and then notify the user.
2. For other modules, there is no lead fail alarm given.

6.7 Parameter alarm

When a certain parameter alarm is closed down, there will be a prompt sign of “” displayed in parameter display area. Alarm On/Off for each parameter can be set separately.

As for set alarm parameter, when a certain parameter or couples of parameters exceed alarm limit, the monitor will automatically give alarm and deals with the followings:

- 1) Appearing prompt on screen, the method is as mentioned in alarm method;
- 2) If alarm volume is set, the alarm sound will be given according to the set alarm level and alarm volume;
- 3) Alarm indicator flashes (if available);

6.8 Measures Taken in Case of Alarm



When a certain alarm occurs, animal's status is to be firstly checked.

Alarm information is displayed in system information area or system alarm information area. This alarm is required to be recognized and corresponding measures should be taken according to alarm reasons.

- 1) Check status of the animal;
- 2) Recognize which parameter is giving alarm or which kind of alarm is happening;
- 3) Recognize alarm reason;
- 4) Alarm is mute if needed;
- 5) After alarm status is released, check if alarm is removed.

Refer to chapters of parameter monitoring for alarm information and prompt of the parameter.

Chapter Seven Recorder (Optional)

- General Information of Recorder
- Method of Configuration and Recording
- Recording

7.1 General Information of Recorder

The recorder used on this monitor is a thermosensitive array recorder with a waveform printing width of 48mm.

Capability of the recorder

- Waveform output of the recorder may be at a speed of 25mm/second or 50mm/second;
- Max. two waveform are to be recorded;
- Output in English;
- Real time recording time and waveform;
- when recording alarm, the monitor automatically select waveform in relation to alarm parameter.

7.2 Type of Record

This monitor produces the following strip-beam record:

- Real time 8 seconds record

Real time Record

Waveform of 8 seconds real time record is set by the animal monitor (generally the first two waveforms are displayed).



When executing output operation, press again printing key, parameter output will be re-exported after the current output ends.

7.3 Record Output

Date Time

HR—heart rate

PR—pulse rate

ST—ST value

SPO2—blood oxygen saturation

SYST—Systolic blood pressure

MEAN—mean blood pressure

DIAS—Diastolic blood pressure

TEMP1—Temperature 1

TEMP2—Temperature 2

RESP—Respiration

LEAD—Lead

7.4 Information of Recorder's Operation and State

Requirement for recording paper

Thermosensitive recording paper which is up to the mustard is required, otherwise, fail of recording, poor quality of recording or damage of thermosensitive head will be caused in.

Normal Operation

- During normal operation of the recorder, the recording paper is delivered smoothly. Do not pull out the paper to avoid damage against the recorder.
- Using the recorder with recording paper unavailable is prohibited.

Steps for replacing paper on recorder

- Open the door of recorder;
- Straightly insert the new paper into paper insert scoop with printing side towards thermosensitive head;
- When the other edge of the paper comes out, pull it out. Pay attention to place the paper properly for no dislocation of papers;
- Close the door of the recorder.



Replace the paper with care not to touch the thermosensitive head. Do not keep the door of the recorder open unless for paper replacement or troubleshooting.

Removing out the jammed paper

In case of abnormal recorder operation sound heard and recording paper delivered, open the door of the recorder to check if paper jammed. For removing the jammed paper:

- Open the door of the recorder;
- Place again properly the paper so as to be without dislocation;
- Close the door of the recorder.

Chapter Eight Electrocardiogram and Respiration (ECG/RESP)

8.1 ECG Monitoring Instruction

8.1.1 Definition of ECG Monitoring

ECG monitoring produces continuous waveform of the animal's ECG activity. It is used for accurately evaluating physiological state of the animal at that time. Ensure normal connection of ECG cable for correct measuring value. In normal working state, the portable monitor displays three ECG waveforms at same time.

- Use 5-lead device for monitoring. ECG may acquire three kinds of waveform from the two different leads.
- Parameters displayed by monitor include HR, ST segment measuring value and arrhythmia (optional)
- All the above parameters may be served as alarm parameters.

8.1.2 Precautions for ECG Monitoring



During defibrillation, keep it away from animal, table or equipment.



It is a must to use ECG cable provided by our company for ECG signal monitoring with the portable animal monitor.



When connecting pole or cable, ensure that they do not contact with other conductive parts or ground. Particularly, ensure that all ECG poles including neutral pole adhere closely to animal to prevent them from contacting with conductive parts or ground.



ECG cable with no resistance can not be used for defibrillation on the monitor; it can not be used for defibrillation on other monitors if the monitor is not equipped with a defibrillation current-limiting resistance.



Interference from the unearthed instruments near the animal and ESU may cause problems to waveform.

8.2 Operation Method of ECG Monitoring

8.2.1 Preparation

- 1) Make skin preparation of the animal before placing poles;
 - Skin is a poor conductor. Therefore, animal's skin preparation is very important for a good contact between the poles and skin.
 - If necessary, give a shaving for placing the poles.
 - Wash clean the skin with soap and water(Aether and pure alcohol are prohibited, because they increase skin impedance).

- Dryly rub the skin to increase tissue’s blood stream of the capillary vessels, and remove the skin scale and lipid.
- 2) Mount pinchcock or snappers before placing the poles.
- 3) Place the poles onto the animal. If poles without conductive paste used, apply conductive paste before placing the poles.
- 4) Connect pole lead with animal cable.
- 5) Make sure that power is switched on.

⚠Warning⚠

Check if ECG pole shoe stimulates skin every day. If there is allergic evidence found, substitute the pole or change position for every 24 hours.

⚠Attention⚠

For protection of environment, the used pole must be reclaimed or properly managed.

⚠Warning⚠

It is necessary to check if the leads are normal before start monitoring. After plugging out the ECG cable, “Sensor fail” will be displayed on the screen and sound alarm will be triggered.

8.2.2 Installation of ECG Lead

Position of ECG Monitoring Poles

The way to place 5-lead device pole is shown in picture 8-1.

- Red (the right forelimb) pole - place under clavicle which is close to the right shoulder.
- Yellow (the left forelimb) pole - place under clavicle which is close to the left shoulder.
- Black (right hind) pole — place at lower right abdomen.
- Green (left hind) pole – place at lower left abdomen.
- White (Chest) pole – place onto chest as shown in picture 8-1

⚠Attention⚠

Lead names of USA standard and European standard are listed in the following table (R, L, N, F, C denote lead in European standard, while in USA standard, RA, LA, RL, LL, V are used instead.)

USA		Europe	
Name of lead	Color	Name of lead	Color
RA	white	R	red
LA	black	L	yellow
LL	red	F	green
RL	green	N	black
V	brown	C	white

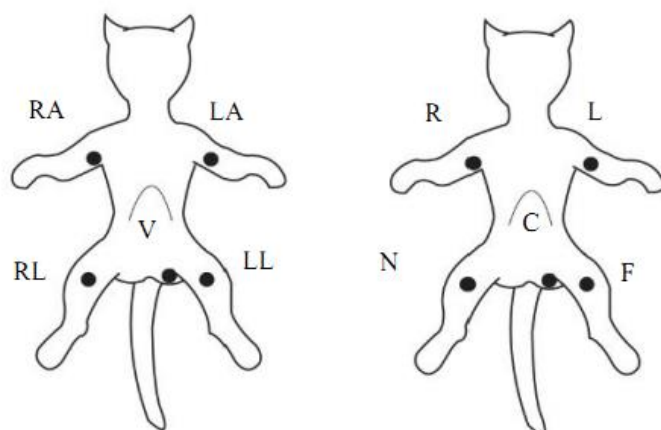

RA:white; LA:black; V:brown; RL: green; LL: red

Picture 8-1 Position of 5-lead Pole

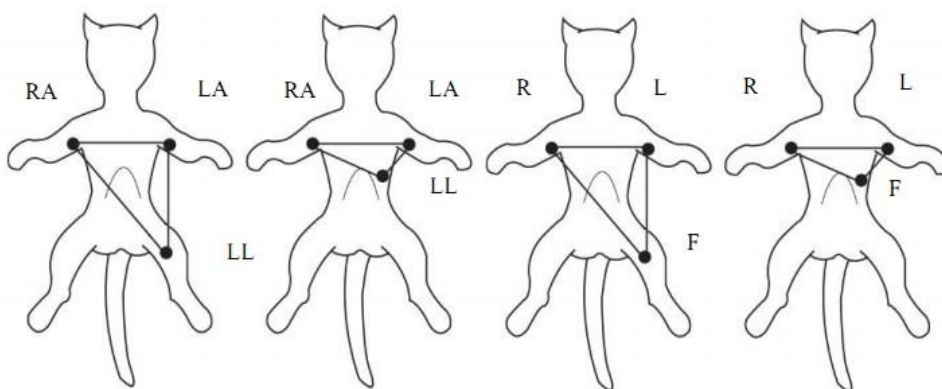

RA:white; LA:black; V:brown; RL: green; LL: red

Picture 8-2 Position of 3-lead Pole

⚠Attention⚠

To ensure safety of the animal, all leads must be connected to the animal.

ECG Lead Connection Recommended to Surgical animal

⚠Warning⚠

When using ES equipments, place ECG pole at the middle position between ES earth-plate and ES knife to avoid burn. Cables of ES equipments and ECG can not be intertwined.

Placement of ECG lead depends on the type of operation. For example: for thoracotomy, poles may be placed at thorax lateral or dorsal. In operation room, because ES knife is used, sometimes fake difference may affect ECG waveform. For reducing fake difference, the pole may be placed at left and right shoulder, close to left and right side of abdomen. Axillary lead may be placed at left side of axillary center. Do not place the pole onto the upper arm, otherwise, ECG waveform may be very small.

⚠Warning⚠

When using ES equipments, placing the pole onto ES equipment earth-plate is strictly prohibited. Otherwise, there will be plenty of interferences on ECG signal.

⚠Attention⚠

If the pole is stacked correctly, but ECG waveform is incorrect, replacing lead is required.

⚠Attention⚠

Interference from unearthed instruments near the animal and ESU may cause in problems to waveform.

8.3 ECG Menu

ECG Setting Menu

Turn the knob, move the cursor on the main screen to ECG hot key in parameter area, then press the knob to pop up ECG setting menu as shown in picture 8-3.



Picture 8-3 ECG Setting Menu

- ECG Alarm setting
- HR alarm: if selecting “On”, alarm prompt and storing will be performed in case of HR alarm; if selecting “Off”, there will be no alarm given, and the prompt of “~~⚠~~” will be displayed by screen parameter area.
- Alarm level: “High”, “Middle” and “Low” are available for option. “High” means the most dangerous alarm.
- Alarm recording: if selecting “On”, record output will be performed in case of HR alarm.
- Alarm upper limit: used to set HR alarm upper limit.
- Alarm lower limit: used to set HR alarm lower limit.
Alarm will be given in case of that HR is higher than the upper limit or lower than the lower limit.



Set alarm upper and lower limit according to the clinical status of each animal.

Upper limit of HR alarm is very important for monitoring. The upper limit should not be set to the extreme high. Taking change into consideration, do not set HR alarm upper limit 20 beats/minute higher than HR of the animal.

■ Source of HR

ECG, SOP2 may be selected freely to test HR; if selecting “Automatic”, the animal monitor will decide the source of HR according to the quality of signal; if selecting “Simultaneity”, the animal monitor will display HR and PR at the same time . If provided by SPO2, PULSE will be notified and PR sound available.

When SPO2 is selected for the source of HR, HR alarm judgment will not be performed, but PR alarm judgment performed.

When selecting the option of “Select all”, PR measurement value will be displayed at right of main screen SPO2; HR and PR alarms are given at the same time. Heart beating sound is subject to HR. If HR is with data, there will be with sound prompt. If there are no HR data, there will be sound prompt for PR.

■ Selecting HR channel

“P1” means to calculate HR with waveform data of the first ECG waveform.

“P2” means to calculate HR with waveform data of the second ECG waveform.

“Automatic” means that HR calculation channel is selected automatically by the animal monitor.

■ Type of lead: 5-lead and 3-lead are optional.

■ Waveform speed

Three options of ECG scanning speed of 12.5, 25.0 and 50.0mm / s are available.

■ ST Segment analysis

Select this option to enter into “ST Segment analysis” menu.

■ Arrhythmia analysis: (this function is unavailable on this animal monitor.)

■ Other settings

Select this option to enter into “ECG setting” menu as shown in picture 8-4.



Picture 8-4 ECG setting Menu

There are the following functions in submenu:

- ECG monitoring type: if selecting “Normal display”, three ECG waveforms in 5-lead will be displayed. If selecting “full screen multi lead display”, seven ECG waveforms and a blood oxygen waveform will be displayed in the screen waveform area.
- Heart beating volume: volume level of “off”, “low” “middle” “high” are optional.
- Pacing analysis: when selecting “On”, a row of small dots will be displayed in ECG waveform area.
- Industrial frequency restraint: Inhibiting net electrical interference
- Trap setting: remove communication interference, optional items are “50hz” and “60hz”;
- ECG cascade: this is ECG cascade switches, cascade refers to all ECG waveforms on the screen Occupy the position of 3 waveforms. This function is only effective when ECG monitor type is "normal display" and waveform scanning mode is "refresh".
- ECG calibration: When selecting this option, ECG waveform will be automatically calibrated.
- Default configuration: Select this option to enter into ECG default configuration dialog box. System default configuration can be selected.

■ Waveform of P1 and P2

Lead I, II, III, aVR, aVL, aVF, V are optional.

■ ECG increase



If too strong of the input signal, cutoff peak of wave crest is possible. At the time, user may change ECG waveform increase level manually according to actual waveform to avoid incomplete waveform provided.

Increase for each calculating channel can be selected. There are levels of increase: $\times 0.25$, $\times 0.5$, $\times 1$, and $\times 2$. There is 1mv scale given at left of each ECG waveform. The height of 1mv scale is proportionable with amplitude.

■ Monitoring method

Warning

Only in diagnostic method, the system can provide unprocessed real signals. Under filtering modes of “Monitoring” and “Operation”, there will be different level of distortion caused in to ECG waveform. At the time, the system can only provide basic information of ECG, and there will influence much of the ST segment analysis result. Under operation mode, ARR analysis result may also be influenced partially. Therefore, it is recommended that diagnosis mode is adopted for monitoring animal when interference is small.

More clean and precise waveform can be acquired through filtering.

Three filtering methods are available for option. Under diagnosis mode, unfiltered ECG waveform will be displayed; monitoring method will filtered fake difference possibly causing fake alarm; in operation room, operation method can reduce fake difference and interference from ES equipments.

8.4 ECG alarm Information

Alarm Information

During ECG measuring, possible alarms are divided into physiological alarm and technical alarm. Meanwhile, various kinds of prompt may be produced during ECG measuring. When these alarm and prompt occur, refer to the relevant descriptions in alarm function chapter for visual and aural representations of the animal monitor. On the display, physiological alarm and general prompt (general alarm) are displayed in alarm area, while, technical alarm and the prompt of alarm unable to be triggered are displayed in the information area of the animal monitor.

8.5 ST Segment Monitoring

Attention

When opening ST segment analysis, the animal monitor is in a “Diagnosis” method. User may change it to “Monitoring” or “Operation” method according to need, but at this period of time ST segment value is seriously distorted.

- ST segment arithmetic may measure ST segment elevation or depression on the second lead. The relevant ST measuring results are displayed in ST1 and ST2 of parameter area in digits. “Retrospection of trend plot” and “Retrospection of trend table” may be opened to view the figure and trend data displayed in form of table.
- Measurement value unit of ST segment: mv;
- Meaning of ST measurement value: positive number means elevation, while negative number means depression;
- ST segment measuring scope: -2.0mv, +2.0mv;

Select the option of “ST segment analysis” in the menu of “ECG setting” to enter into the menu as shown in picture 8-5.

ST Segment Analysis Menu



Picture 8—5 ST Segment Analysis Menu

Alarm Setting for ST Analysis Result

- ST segment analysis: This switch is used to set the state of ST segment analysis. Only the switch on can perform ST segment analysis.
- ST alarm: if selecting “On”, alarm prompt and storing will be performed in case of ST analysis result alarm; while, if selecting “Off”, there will be no alarm given and prompt of “

Adjustment range of alarm upper limit and lower limit:

	Max. upper limit	Min. lower limit	single time adjustment
ST	2.0mv	-2.0mv	0.1 mv

 **Attention** 

During making ST segment analysis, abnormal QRS wave group has not been taken into consideration.

Alarm Information and prompt of ST Segment Analysis

- Decide ST segment analysis point: Select this option to enter into “Decide ST segment analysis point” window to set the values of ISO and ST as shown in picture 8-6.
 - 1) SO (base point) : set baseline point. Power-on setting: 80 milliseconds
 - 2) ST (start point) : set measuring point. Power-on setting: 108 milliseconds

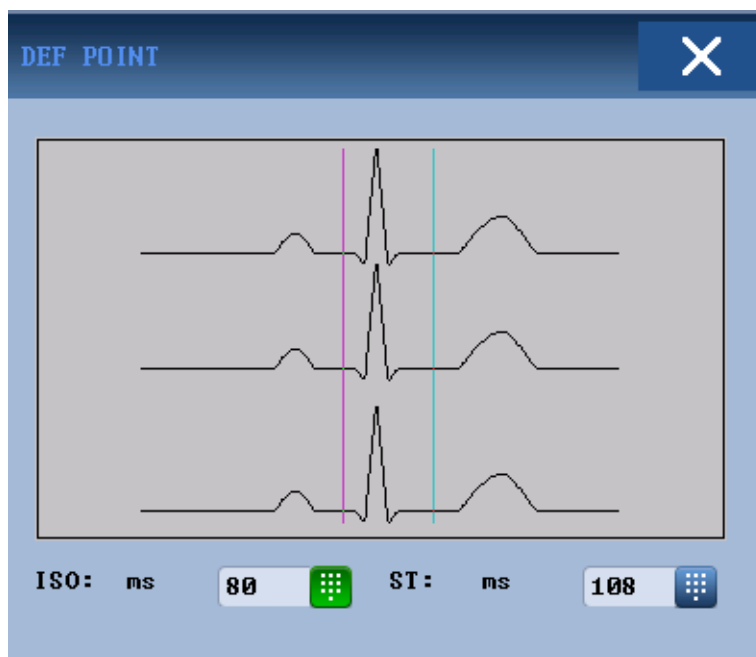

Picture 8—6 Decide ST Segment Analysis Point

⚠Attention⚠

If HR or ECG waveform of the animal has obvious changes, ST measuring point is required to make adjustment. The method is as below:

- Method for ISO and ST adjustment

Adjust the value through turning the knob.

When setting ST segment measuring point, open the window of “Decide analysis point”, at the time, QRS wave group module is displayed in the window (if the channel is not opened, notify “ST analysis switch off”), position of high brightness line in the window is adjustable, select ISO or ST firstly, then turn the knob in direction of left and right to move the brightness line in parallel to decide base point or measuring point.

⚠Attention⚠

QRS wave group has not been taken into consideration while making ST segment analysis.

Alarm Information and Prompt of ST Segment Analysis

⚠Attention⚠

When alarm limits of two ST measurement values are the same, alarm limit for each channel is not able to be set separately.

When alarm recording switch in relevant menu is at On, those physiological alarms caused by parameter overrun of alarm limit will trigger the recorder to output alarm parameter and related measuring waveform

automatically.

8.6 Respirometry

How to measure respiration?

The animal monitor measures respiration from the thorax impedance value of the two poles. The impedance changes (caused by activity of thorax) of the two poles will produce a respiration wave on the screen.

Setting Respiration Monitoring

No more poles are needed to monitor respiration, but placement of poles is very important. Because of clinical status of part of the animals, lateral expansion of their thoraxes cause in negative thorax internal pressure. Under such circumstances, it is better to place the two respiration poles onto midaxillary line and the max. movement area in case of thorax left respiration to acquired the best respiration wave.

⚠Attention⚠

Respiration monitoring is not suitable for the very large movement range animal, because it may cause in false alarm.

RESP monitoring inspection:

- 1) Make animal's skin preparation before placing poles.
- 2) Mount pinchcock or snapper onto the pole, and place the poles onto the animal according to the method as shown in the following picture.

Placing poles for respiration measurement

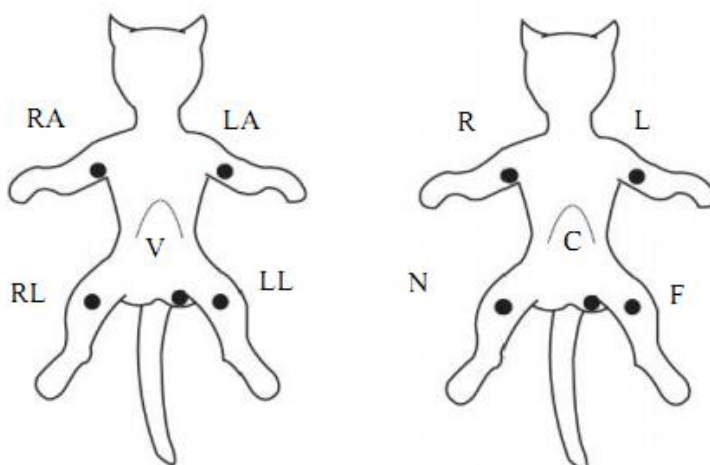

Picture 8-7 Placement of Poles (5-lead)

⚠Attention⚠

Placing white and red poles diagonally is to acquire the best respiration wave. Liver and ventricle should not be on respiration pole line. In this way, fake difference caused by heart covering or palatial blood flow is avoided. This is very important for neonatal baby.

RESP Setting Menu

Turn the knob, move the cursor to RESP hot key in the main screen parameter area, then press the knob to enter into “RESP setting” menu as shown in picture 8-8.

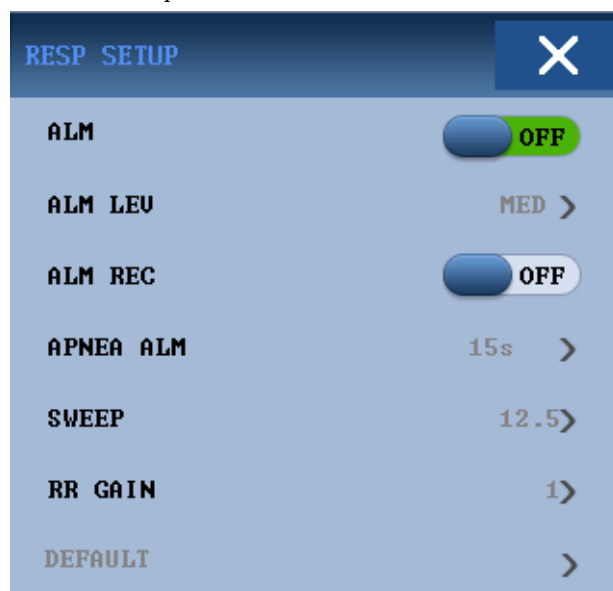

Picture 8—8 RESP Setting Menu

RESP Alarm Setting

- Alarm switch: if selecting “On”, alarm prompt and storing will be performed in case of HR alarm; if selecting “Off”, there will be no alarm given, and the prompt of “” will be displayed by RESP in screen parameter area.
- Alarm recording: if selecting “On”, recorder output will be performed in case of RESP rate alarm.
- Alarm level: “High”, “Middle” and “Low” are available for option. “High” means the most dangerous alarm. RESP rate alarm is subject to the set upper limit and lower limit. In case of overrun of RESP rate, alarm is given.

Adjustment range for RESP alarm upper limit and lower limit:

	Max. upper limit	Min. lower limit	single time adjustment
RR adult	120	0	1
RR children/neonatal baby	150	0	1

- Asphyxia alarm: Set judging asphyxia time of animal, ranging 10 seconds~40 seconds, each turn of the knob will increase/reduce 5 seconds.
- Waveform speed: RESP waveform speed of 6.25mm/s, 12.5mm/s, 25.0mm/s are optional.
- Waveform range: user may set to zoom RESP waveform. Zoom multiple of 0.25, 0.5, 1, 2,4 are optional.
- Default configuration: Select this option to enter into dialog box of “RESP default configuration. User may select “Factory default” or “User default setting”. After selecting exit dialog box, the system will pop up a dialog box to ask the user to confirm the selection.

8.7 Maintenance and Cleaning

Maintenance and Cleaning



It is a must to power off and disconnect AC power before cleaning the animal monitor or sensor.

If there is the representation of ECG cable damage or aging, substitution with a new cable is required.

■ Cleaning

The surface of animal monitor and sensor may be cleaned with medical alcohol. Dry them by natural wind or with clean and dry cloth.

■ Sterilization

To avoid long term damage against the product, it is recommended to perform sterilization in case of necessity according to regulations of the hospital. Cleaning the product before sterilization is also recommended.

Sterilization materials recommended for animal monitor:

- ◆ Ethanol:70% alcohol, 70% ethyl propel
- ◆ Aldehyde

■ Disinfection

To avoid long term damage against the product, it is recommended to perform disinfection in case of necessity according to regulations of the hospital. Cleaning the product before sterilization is also recommended.

Chapter Nine Blood Oxygen Saturation (SpO₂)

9.1 SpO₂ Monitoring Instruction

Definition of SpO₂ monitoring

SpO₂ plethysmography parameter measures arterial SpO₂, name the percentage of the HbO₂. For example: in arterial blood erythrocytes, if hemoglobin counting for 97% of the total combines with oxygen, the blood is at a 97% SpO₂, and the reading of SpO₂ value on the animal monitor 97%. SpO₂ value displays the percentage of Oxygen-carrying hemoglobin forming HbO₂. SpO₂ plethysmography parameter also provides PR signal and plethysmography wave.

SpO₂ plethysmography parameter measurement principle

- SpO₂ is measured with pulse dosimeter. This is a continuous non-invasive measuring method for hemoglobin oxygen saturation. What it measures is the quantity of ray penetrating through the tissues of animal (e.g. finger or ear) emitted from sensor light source and reached the receiver at the other side.

Wave length measured by sensor is generally 660nm for red LED, 940nm for infrared LED. Max. optional output power for LED is 4mW.

- The penetrating ray quantity depends on various factors, and most of them are constant. But one of the factors, namely arterial blood stream, changes as time goes by, because it is pulsant. Through measuring absorbed ray in pulsant period, SpO₂ of the arterial blood can be acquired. Testing pulse may give a “plethysmography” waveform and PR signal.
- “SpO₂” value and “plethysmography” waveform can be displayed on the main screen.
- SPO₂ in this manual means physiological function blood oxygen saturation measured through non-invasive method.



Warning

If exists COHb, MHB or dyeing dilution chemicals, there will be windage for SpO₂ value.

SpO₂ plethysmography parameter measurement

- “SpO₂” value and plethysmography waveform can be displayed on the main screen.
- SPO₂ in this manual means physiological function blood oxygen saturation measured through non-invasive method.



Warning

If exists COHb, MHB or dyeing dilution chemicals, there will be windage for SpO₂ value.

SpO₂/pulse monitoring



Cables of ES equipments and ECG can not be intertwined.



Do not place sensor onto the part of body with arterial conduct or intravenous conduct.



Do not place blood oxygen probe onto as same part of body with blood pressure cuff on. This causes blood obstruction during measuring blood pressure may affect the reading of SpO₂



- SpO₂ value is always displayed at the fixed position.
- PR is displayed only under the following circumstances:
 - 1) “Source of HR” is set to “SP0₂” or “Select all” in ECG menu.
 - 2) “Source of HR” is set to “Automatic”, and there is no ECG signal at that time.



SpO₂ waveform and pulse volume are out of proportion.



Before starting monitoring, check if the sensor cable is normal. When plugging SpO₂ sensor cable out, “Sensor fail” will be displayed on the screen and sound alarm is triggered at the same time.



If there is the evidence of damage on sensor packing or sensor, do not use this SpO₂ sensor and return it to the factory.



Continuous and long term monitoring may increase the risk of skin property changes, such as abnormal allergy, redden, blistering or compression necrosis. They occur more frequently on animals with perfusion obstacle and metabolic or immature skin pose chart. According to quality changes of the skin, it should be paid more attention to check the placement of sensor by correct light route aiming and adhering method. It is required to regularly check the adhering position of sensor and change the adhering position if skin quality decreased. Because of the different status of the animals, more frequent checks may be required for some of the animals.

9.2 Operating method of SpO₂ monitoring

SpO₂ plethysmography measurement

- 1) Power the animal monitor on;
- 2) Place the sensor onto the proper position of animal's ears;
- 3) Insert the connector on one end of sensor cable into SpO₂ jack.

Attention

If measures part and probe can not be positioned accurately, it may cause in inaccurate reading of SpO₂, even pulse wave can not be searched for monitoring blood oxygen. At the time, repositioning is required.

Excessive moving of the measured part may cause in inaccurate measurement. At the time, the animal should have been calmed or place onto a new position to reduce influences to measurement by excessive moving.

Warning

During the course of long term and continuous monitoring, peripheral circulation status and skin status should be checked once every 2 hours. If bad changes found, measuring position should be changed timely.

During the course of long term and continuous monitoring, it is required to regularly check the position of the probe to prevent moving of the probe from influencing the accuracy of measurement.

9.3 Measurement Limit of SpO₂ Monitoring

During operating, the following factors may influence the accuracy of SpO₂ measurement:

- High frequency electric interference, like interference generated by the main unit or ES equipments connecting with the system.
- During MRI, do not use oximeter, blood oxygen sensor. Inductive current may cause in burn.
- Intravenous dye.
- Excessive moving the animal.
- Outside light radiation.
- Improper installation of the sensor or improper contacting position with the object.
- Temperature of the sensor (the most suitable temperature range: 28°C~42°C)
- Place sensor onto part of the body with blood pressure cuff, arterial conduct or line in cavity.
- Concentration of non-functional hemoglobin like COHb and MetHb.
- Excessive low SpO₂.
- Poor circulation perfusion of the measured part.
- Shock, anaemia, low temperature and vasoconstrictor may lower the arterial blood stream to the level at which measurement can not be performed.
- Measurement also depends on absorption of the oxygenated hemoglobin and reduced hemoglobin for special wave length ray. If there are other substances absorbing the same wave length existing, they cause in fake or low SP₀₂ value of the measurement. E.g. COHb, MetHb, Methylene Blue, Indigo Carmine.
- Sp₀₂ sensor。

9.4 SpO₂ Menu

Sp₀₂ Setting Menu

Turn the knob, move the cursor on display interface to SP₀₂ hot key in parameter area, press the knob to enter into the menu of “SP₀₂ setting”, as shown in picture 9-1.



Picture 9—1 SpO₂ Setting Menu

⚠Warning⚠

Setting SpO₂ alarm upper limit to 100% means disconnecting alarm upper limit. High-oxygen water may cause premature ill with crystal post fiber tissue diseases. Therefore, alarm upper limit of SpO₂ must be carefully set according to recognized clinical practice.

SpO₂ Alarm Setting

- Alarm switch: if selecting “On”, alarm prompt and storing will be performed in case of SpO₂ alarm; if selecting “Off”, there will be no alarm given, and the prompt of “” will be displayed by SpO₂ in screen parameter area.
- Alarm recording: if selecting “On”, record output will be performed in case of SpO₂ alarm.
- Alarm level: “High”, “Middle” and “Low” are available for option. “High” means the most dangerous alarm.

SpO₂ and PR alarm range:

Parameter	Max. upper limit	Min. lower limit	Single time adjustment
SpO ₂	100	0	1
PR	254	0	1

SpO₂ and PR default alarm range under default configuration:

Parameter		Max. upper limit	Min. lower limit
SpO ₂	Large animal	100	90
	Medium animal	100	90
	Small animal	95	85

PR	Large animal	120	50
	Medium animal	160	75
	Small animal	200	100

- **Waveform speed**
12.5 and 25.0mm/s are optional for SpO2 plethysmography speed.
- **Pulse volume:** “off”, “low”, “middle” and “high” levels of pulse volume are optional.
- **Calculation sensitivity:** Select average time for calculating SpO2 value. Selection of “High”, “Middle” and “Low” means the average value of 4 seconds, 8 seconds and 16 seconds.
- **Default configuration:** Select this option to enter into SPO2 default configuration dialog box. System default configuration may be selected.

9.5 SpO2 Alarm Information

SpO₂ alarm information

When alarm recording switch in the menu is switched on, those physiological alarms caused by parameters' overrun of alarm limit will trigger the recorder to automatically output alarm parameter value and related measured waveforms.

9.6 Maintenance and Cleaning

Attention and Cleaning



Warning

It is a must to power off and disconnect power supply before cleaning the animal monitor or sensor.



Caution

Do not have the sensor sterilized with high pressure.

Don't dip the sensor into liquid.

They are prohibited to use in case of evidence of damage or degeneration of the sensor or cable.

Cleaning:

- Surface of the sensor may be wiped with cotton balls or soft cloth dipped medical alcohol, and then dry it with dry cloth. Emitting light tube and receiver of the sensor may be cleaned in the same method.
- Cable may be disinfected with 3% Hydrogen Peroxide or 70% isopropyl alcohol. Active agent is also effective. Joint can't be dipped in solution.

Chapter Ten Temperature (TEMP)

10.1 TEMP Monitoring Instruction

Portable animal monitor may use two temperature probes at the same time. Two temperature data measured out and differences acquired.

TEMP Measurement Setting

- If the disposable temperature probe is being used, temperature cable must be inserted into the faucet and then the probe and cable are to be connected. You may insert the repeatable temperature probe directly into the faucet.
- Adhere temperature probe securely onto the animal.
- Insert temperature probe into animal body cavity.

Warning

Before starting monitoring, it is required to check if probe cable is normal. Plug out temperature probe cable of P1 out the faucet, “T1 sensor fail” will be displayed on the screen and sound alarm given. Other channels are similar to P1.

Attention

Disposable temperature probe can be used for only one time.

Warning

Be careful with the temperature probe and cable. If idle, twist the probe and cable into a loose ring. If the wire is pulled excessively tight, mechanical damage will be caused in.

Warning

It is a must to have the temperature measuring meter calibrated once very two years (or follow hospital's regulation).

Attention

During monitoring, temperature measuring meter will automatically make s self-test once an hour. Self-test will last 2 seconds and that will not affect the normal operation of the temperature monitor.

10.2 TEMP Menu

User may move the cursor to TEMP hot key in parameter area on the main screen through the knob, press the knob to enter into the menu of TEMP setting, as shown in picture 10-1.

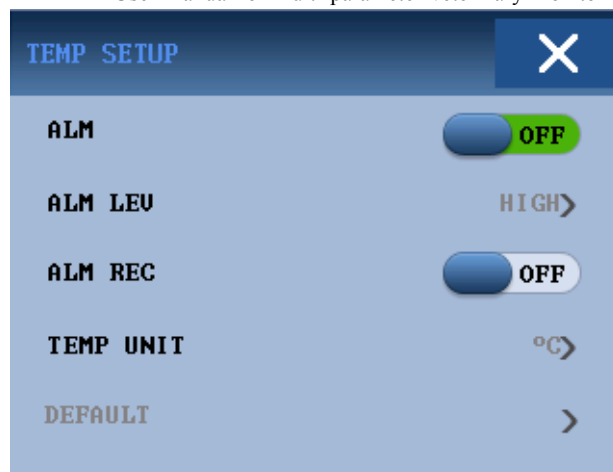

Picture 10— 1 TEMP setting Menu

- ◆ Alarm switch: if selecting “On”, alarm prompt and storing will be performed in case of TEMP alarm; if selecting “Off”, there will be no alarm given, and the prompt of “

10.3 TEMP Alarm Information and Prompt Information

When alarm recording switch in relevant menu is at On, those physiological alarms caused by parameter overrun of alarm limit will trigger the recorder to output alarm parameter and related measuring waveform automatically.

10.4 Maintenance and Cleaning

Warning

It is required to power off and disconnect power supply before cleaning this equipment and sensor.

Repeatable temperature probe:

- 1) Temperature probe cannot be heated over 100°C(212°F). It can only bear the temperature of 80°C(176°F)~100°C(212°F) within a short period of time.
- 2) Do not have the probe disinfected with steam.
- 3) Use only the scour with alcohol for disinfection.
- 4) When using normal probe, try to hitch it with protective rubber.
- 5) For washing the probe, one hand holds the probe, the other rub the probe with a wet lint free cloth downward to the connector.



It is prohibited to re-disinfect or repeatedly use the disposable temperature probe.



For protection of environment, disposable temperature probe should be reclaimed or properly managed.

Chapter Eleven Non-invasive Blood Pressure (NIBP)

11.1 NIBP Monitoring Instruction

- NIBP is measured with oscillometry;
- It is applicable to large animals, medium-sized animals and small animals;
- Measuring mode: manual, automatic and continuous. Systolic, mean and diastolic blood pressure will be display in each mode.
 - “Manual” mode measure only once.
 - “Automatic” mode measure repeatedly.
Time interval may be set to 1/2/3/4/5/10/15/30/60/90/120/180/240/480 minutes.
 - “Continuous” mode measures continuously in 5 minutes.

Warning

NIBP measurement can not be performed on the patients who are ill with sickle-cell disease and those who have skin damage or foreseen damage. Because they will lead to serious coagulation mechanism obstacle. Automatic blood pressure measurement is determined by clinical evaluation because the place where the part of body contacting the cuff risks hematoma.

When NIBP measurement is to use on medium-sized animals and small animals, it should be guaranteed that correct mode setting has been selected (Refer to patient’s information menu setting.) Using incorrect patient’s mode may endanger the patient. This is because the large animals’ blood pressure level is unsuitable for medium-sized animals and small animals.

11.2 Operating method for NIBP Monitoring

11.2.1 NIBP Measurement

Tube used to connect cuff with the patient monitor should be kept unobstructed.

1. Insert the tube into cuff joint, and start the equipment.
2. Tie the cuff on fore or hind legs of the animal, as shown in picture 11-1.

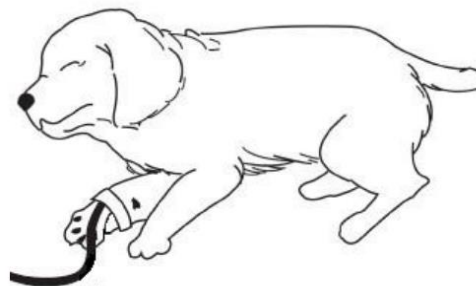

Picture 11-1 Use of cuff

- ◆ Make sure that the cuff is absolutely deflated.
- ◆ Use the cuff of suitable size to ensure that it is placed right on the proper artery. Ensure the cuff is not too tight, otherwise color change or even ischemia of far end of body may occur.

 **Attention** 

Width of the cuff should be 40% of body perimeter. (50% for small animals), or 2/3 of the upper arms and legs in length. Length of charged part of the cuff should be enough to entwist 50~80% of the body. Cuff of unsuitable size may give incorrect reading. The edge of the cuff should be placed within the marked range, otherwise it is necessary to substitute a new cuff.

Repeatable cuff for small /medium-sized / large animals

Type of patient	Perimeter of body	Cuff width	Length of charge tube
small animals	10~19cm	8cm	
medium-sized animals	18~26cm	10.6cm	1.5m
large animals1	25~35cm	14cm	or
large animals2	33~47cm	17cm	3m
leg	46~66cm	21cm	

Disposable small /medium-sized / large animals

Size	Perimeter of body	Cuff width	Length of charge tube
1	3.1~5.7cm	2.5cm	
2	4.3~8.0cm	3.2cm	1.5m or
3	5.8~10.9cm	4.3 cm	3m
4	7.1~13.1cm	5.1cm	

- ◆ Check if the cuff edge locates in the area marked with <->. If not, substitute with a proper one
3. Make sure if monitoring method is correct (monitoring method is displayed in animal monitor information area at right side of sickbed number.). If changing monitoring method is needed, please enter into “patient’s information setting” in “system menu” to change “Type of animal”.
 4. Select measuring method in NIBP menu. Refer to the “Operation prompt” below for details.
 5. Press “START” key on the front panel to begin measuring pressure.

Operation Prompt

1. One automatic measuring

Enter into “NIBP setting” menu, select the option of “Time interval”. User may select time interval value for automatic measurement. Then, press START key on the front panel, the system will automatically charge for measurement according to the set time interval.

 **Warning** 

If NIBP in automatic mode lasts excessively long, purpuric, ischemic and nervous and nerve damage may be caused in onto the place where the cuff contacts the body. During monitoring, it is required to regularly check the color, warm degree and sensitivity of body far end. If abnormality found, place the cuff onto another place or stop measuring.

2. Stop automatic measuring

Press START key at any time during automatic measuring to stop automatic measuring.

3. One manual measuring

◆ Enter into “NIBP setting” menu, select “Time interval”, set the value to “Manual”, then press START key on the front panel to begin a manual measuring.

◆ At an idle moment during automatic measuring, press START key to begin a manual measuring. If press START key again at that time, manual measuring will be stopped, but to execute automatic measuring.

4. One manual measuring during automatic measuring

Press START key on the front control panel.

5. Stop one manual measuring on midway

Press again the START key on the front control panel.

6. Continuous measuring

Enter into “NIBP setting” menu, select “Continuous measuring” to begin continuous measuring. The course lasts 5 minutes.

Warning

If NIBP in continuous mode lasts excessively long, purpuric, ischemic and neverous and nerve damage may be caused in onto the place where the cuff contacts the body. During monitoring, it is required to regularly check the color, warm degree and sensitivity of body far end. If abnormality found, place the cuff onto another place or stop measuring.

7. Stop continuous measuring on midway

Press START key at any time during continuous measuring to stop continuous measuring.

Attention

If doubting about the accuracy of the reading, check animal’s vital signs with possible methods before checking the function of the animal monitor.

Warning

If liquid splashes the equipment or accessories, particularly when the liquid is possible to enter into conduct or the animal monitor, please contact hospital maintenance department.

Measuring limit

According to status of the animal, measuring with oscillometry is with limitation. What this measuring seeks for is the regular pulse wave generated by arterial pressure. If this measuring becomes very difficult due to the animal, the measuring value is unreliable, and measuring time is increased. User should know that the following circumstances will interfere with measuring method making pressure measuring unreliable or pressure measuring time longer. Under such a circumstance, animal’s status causes measuring unably performed.

■ Moving of animal

If the animal is moving, trembling, or in convulsion, measuring is unreliable or impossible. This is because such circumstances may interfere with checking of arterial pressure pulse, and blood measuring time will be enlengthened.

■ Arrhythmia

If the animal is displayed with arrhythmia and irregular heart beat caused in, measuring will be unreliable or even

can not be performed, and measuring time is enlengthened.

■ Heart-lung machine

If animal uses artificial heartOpung machine for connection, measuring can not be performed.

■ Changes of pressure

If in a certain period of time, arterial pressure pulse is being analyzed to acquire measuring value, blood pressure of the animal changes rapidly, and measuring is unreliable or even can not be performed.

■ Serious shock

If the animal is with serious shock or excessive low TEMP, measuring is unreliable, because increase of the blood stream peripherally flowing may lower arterial pulse.

■ Ultimate heart rate

Blood pressure measuring can not be performed if HR is lower than **40bpm**(beat/minute) and higher than **240bpm**(beat/minute).

11.2.2 NIBP Parameter Setting and adjustment

Display layout of NIBP measuring result and corresponding information on screen:

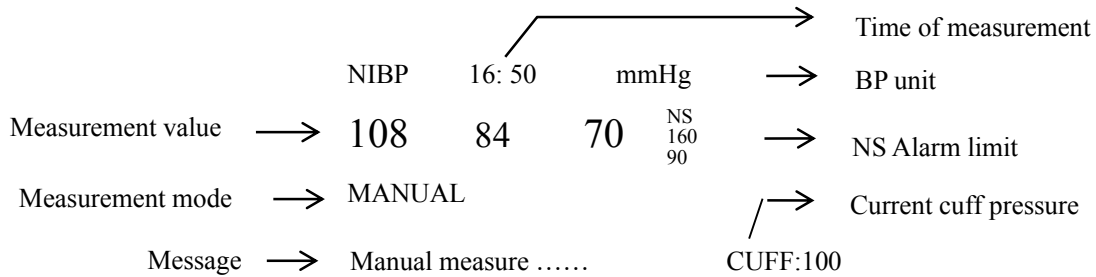

11.3 NIBP Menu

Turn the knob, move the cursor to NIBP hot key in parameter area of the screen, press the knob to enter into the menu of “NIBP setting”, as shown in the picture n11-2.



Picture 11—2 NIBP Setting Menu

- NIBP Alarm Setting
 - ◆ Alarm switch: if selecting “On”, alarm prompt and storing will be performed in case of pressure alarm; if selecting “Off”, there will be no alarm given, and the prompt of “
 - Reset

Measure state of blood pump reset.

Press this key to have charge value of the blood pump be back to the initial setting.

When blood pump is with abnormal work and the animal gives no prompt from the problem, this key is recommended to use. This is because it will make the blood pump perform self-test and automatically recover if the abnormality is caused by accidental reasons.

- Continuous measuring

Start continuous measuring

After selecting this option, the menu will automatically disappear and start continuous measuring at once.

- Time interval

Automatically measure time interval (unit: minute). Options of 1, 2, 3, 4, 5, 10, 15, 30, 60, 90, 120,

180, 240, 480 minutes are available. After selecting the interval, a prompt of “Press “start” key” will be displayed in the NIBP prompt area. At the time, press START key to start charging for the first time automatic measuring. To stop automatic measuring, it is required to select “Manual” to turn back to manual mode at measuring interval.

■ Pressure unit

mmHg or kPa are optional.

■ Pressure calibration



It is required to have a NIBP measuring calibration for very two years (or follow your maintenance regulation).

- Default configuration: Select this option to enter into NIBP default configuration dialog box. In the dialog box, there are two options available: “Factory default configuration” and “User default configuration”. Select any one to exit dialog box. The system will pop up a dialog box to ask user to confirm the selection.

■ Pressure calibration

It is recommended to use manometer with a min. precision of 1 mmHg (Mercurial Blood-Pressure Meter). Select “Calibration” to start calibrating. Meanwhile this option changes to “Stop calibration”. If pressing this key at this moment, the system will stop calibration.



Calibration of NIBP measuring should be made once every two years (or follow your maintenance regulation). Check its performance according to the followings.

Calibrating steps for pressure sensor:

Substitute the cuff with a metal container at a cubage of 500ml±5%. Insert a calibrated standard manometer with a max. tolerance of 0.8mmHg, an air pump with T-shape interface and a charge tube into the NIBP jacks on the module. Set the animal monitor to “Standard”, increase the pressure in the metal container to 0, 50 and 200 mmHg with air pump. At the time, the difference between the value of standard manometer and the pressure demonstrated on the animal monitor should be less than 3 mmHg. Otherwise, contact maintenance technicians of our company.

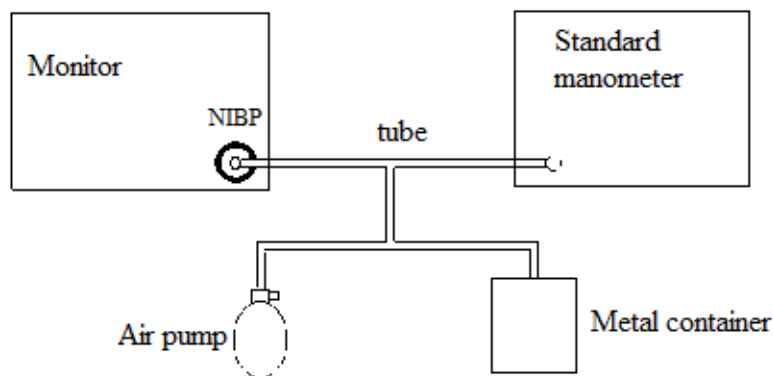

Picture 11-3 NIBP calibration connection

■ Leak test

It is used to test leak of NIBP measuring pump. When connecting through with the cuff, use this key to start NIBP charge to check if the enclosed air route is normal. If passed the leak test, the system gives no prompt; if failed, there will be error prompt displayed in NIBP information area.

⚠Warning⚠

The leak test is different from the content in EN 1060-1 Standard. Is used to simply test leak in NIBP charge. If NIBP leak is displayed by the system, please contact the maintenance technicians of our company.

Steps for leak test:

- 1) Connect secure the cuff with NIBP air hole of the monitor.
- 2) Enwind the cuff onto a proper size column.
- 3) Enter into “NIBP setting” menu.
- 4) Turn the knob, move the cursor to option of “Leak test”, press the knob. At the time, on lower part of the NIBP parameter area on the screen will notify “Leak testing...”, indicating that the system starts leak test.
- 5) The system automatically charge to the pressure 180mmHg.
- 6) Roughly 20 seconds later, the system automatically opens the air valve to deflate, marks leak test completed.
- 7) If there is no prompt displayed in NIBP parameter area, it means no leak on the system. If “Pump leak...” is displayed, it means that there is possible leak in air route. At the time, the operator should check if the all joints are secure. If yes, make a leak test once more. If still with failure prompt, please contact the manufacturer for servicing.

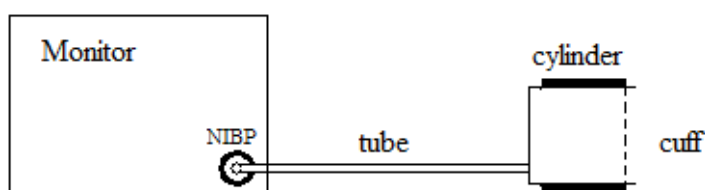

Picture 11-4 leak test connection

- Default configuration: Select this option to enter into NIBP default configuration dialog box. System default configuration may be selected.

11.4 Maintenance and Cleaning

⚠Warning⚠

- Do not press the rubber tube of the cuff.

- **Prevent water or wash solution from entering connector socket on front of the monitor.**
- **When cleaning the monitor, wipe the surface of the connector socket, but not the inside of it.**
- **When the repeatable cuff is not connected with the monitor or being cleaned, the lid should always be on the rubber tube to prevent liquid from entering the rubber tube and being absorbed by the module.**

Repeatable cuff

The cuff can be sterilized with high pressure in regular hot air oven, or disinfected with gas or radiation, or sterilized by dipping into detergent solution. Do remember to take down the rubber bag if this method adopted. Dry-cleaning of the cuff is prohibited. The cuff can be washed with machine or hand. Hand wash will prolong its lifespan. Before washing, take out the rubber bag. After washing and when the cuff is dried absolutely, mount back the rubber bag.



For protection of environment, the disposable blood pressure cuff must be reclaimed or managed properly.

Chapter Twelve IBP Monitoring (Optional)

12.1 Introduction

The Monitor measures direct blood pressure (SYS, DIA and MAP) of one selected blood vessel through two channels, and displays two BP waveforms measures direct blood pressure (SYS, DIA and MAP).



Picture11-2 IBP screen

The available pressure labels are:

Label	Definition
ART	Arterial Blood Pressure
PA	Pulmonary Arterial Pressure
CVP	Center Venous Pressure
RAP	Right Atrial Pressure
LAP	Left Atrial Pressure
ICP	Intracranium Pressure
P1-P2	Expand Pressure

12.2 Precautions during IBP Monitoring

Warning

The operator should avoid contact with the conductive parts of the appurtenance when being connected or applied.

⚠Warning⚠

When the monitor is used with HF surgical equipment, the transducer and the cables must be avoided conductive connection to the HF equipment to protect against burns to the animal.

⚠Warning⚠

Disposable IBP transducer or domes should not be reused.

⚠Note⚠

Use only the pressure transducer listed in the Chapter Accessories and Ordering Information.

The specified transducer is designed to have the special ability to protect against the electricity shock (especially for the leak current allowed), and it is protected against the effects of a discharge of a cardiac defibrillator. It can be used in the surgical operation. When the animal is in the defibrillation, the waveform of the pressure maybe distorted temporarily. After the defibrillation, the monitoring will go on normally, the operation mode and the user configuration are not affected.

⚠Warning⚠

Verify transducer cables fault detection before beginning of monitoring phase. Unplug the transducer of the channel 1 from the socket, the screen will display the error message “IBP: SENSOR 1 OFF” and the audible alarm is activated. The other channel is the same.

⚠Note⚠

Calibrate the instrument either whenever a new transducer is used, or as frequently as dictated by your Hospital Procedures Policy.

⚠Warning⚠

If any kind of liquid, other than solution to be infused in pressure line or transducer, is splashed on the equipment or its accessories, or may enter the transducer or the monitor, contact the Hospital Service Center immediately.

12.3 Monitoring Procedure

Preparatory steps for IBP measurement:

1. Plug the pressure cable into corresponding socket and check that the monitor is switched on.
2. Prepare the pressure line and transducer by flushing through the system with normal saline solution. Ensure that the system is free of air bubbles.
3. Connect the animal catheter to the pressure line, making sure that there is no air present in the catheter or pressure line.

⚠Warning⚠

If there are air bubbles in the pressure line or the transducer, you should flush the system with the

solution to be infused.

4. Position the transducer so that it is at the same level with the animal's heart, approximately mid-axillary line.
5. Check if you have selected the correct label name. See the next section for details.
6. Zero the transducer. See the next section for details.

12.4 IBP Menu

Tuning the knob to choose ECG opinion, then press the knob to call for IBP setting menu which shown as Picture11-2:



Picture 11-2 IBP SETUP Menu

The items to be set up in the menu include:

- ALM: Select "ON" to enable alarm prompt and data storage during IBP alarm. Select "OFF" to disable audio alarm and prompt the  symbol beside "IBP" numeric.
- ALM LEV: used to set up the alarm level. Three levels are available: HIGH, MED, LOW.
- ALM REC: Select "ON" to enable recording during the IBP alarm or to OFF to disable the alarm recording function.
- AMP ADJUST: used to adjust waveform amplitude. Two selections are available: MANUAL, AUTO. Set it

to AUTO, the pressure names of IBP become P1 and P2 (or P3, P4), and the IBP scale is adjusted by system automatically. Set it to MANUAL, the pressure names of IBP can choose one of ART, PA, CVP, RAP, LAP, ICP, P1, P2, and the IBP scale is adjusted by the user via SCALE ADJUST item.

- SWEEP: used to select the scanning speed of the IBP wave. Two selections are available: 12.5 mm/s or 25 mm/s.
- UNIT: used to select the pressure unit (mmHg or kPa).
- FILTER: used to select the filtering way to be adopted by the system. Three selections are available: NORMAL (filtering the waveform in 16Hz frequency), SMOOTH (filtering the waveform in 8Hz frequency) and NO FILTER (display the original waveform). The default value is NO FILTER.
- ALM LIMIT SETUP: used to access the sub-menu of IBP ALM LIMIT SETUP, in which the user may set up the upper and lower alarm limit of systolic pressure, diastolic pressure and mean pressure respectively for channel 1 and channel 2.
- SCALE ADJUST: used to access the sub-menu of IBP SCALE ADJUST, in which the user may adjust the position of the high, reference and low scales for the two waveforms displayed on the screen.
- EXPAND PRESSURE: used to access the sub-menu of IBP EXPAND PRESSURE, in which the user may select the pressure name to be represented by P1, P2.
- OTHER SETUP: used to access the sub-menu of TRANSDUCER ZERO or IBP CALIBRATE in which the user may return the IBP data to zero or correct the IBP error.
- DEFAULT: pick this item to access the IBP DEFAULT CONFIG dialog box, in which the user may select whether the FACTORY DEFAULT CONFIG or the USER DEFAULT CONFIG is to be used. After selecting any of the items and exiting the dialog box, the system will pop up the dialog box asking for the user's confirmation.

Warning

Before set the alarm limits, confirm to choose the correct label.

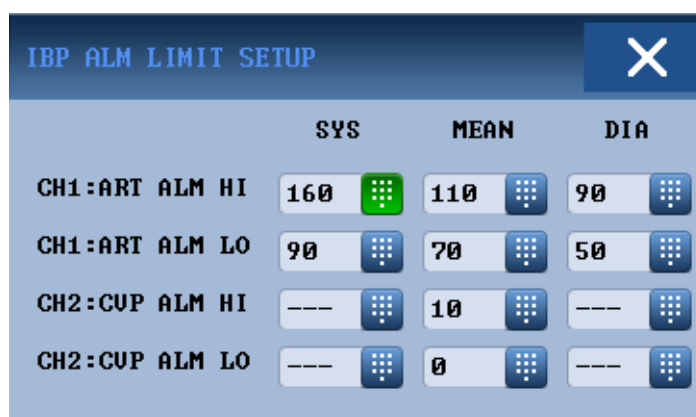

Picture 11-3 IBP ALM LIMIT SETUP

The alarm occurs when the value exceeds the set limits.

IBP alarm limits:

Pressure Label	Max. Alarm High (mmHg)	Min. Alarm Low (mmHg)	Step (mmHg)
ART	300	0	1
PA	120	-6	1
CVP	40	-10	1
RAP	40	-10	1
LAP	40	-10	1
ICP	40	-10	1

Using this opinion to access “IBP OTHER SETUP” menu, which shown as following:



Picture 11-4 IBP OTHER SETUP

IBP Transducer Zero

Press the IBP PRESSURE ZERO button on the IBP SELECT menu to call up IBP PRESSURE ZERO menu as shown below:



Picture 11-5 IBP PRESSURE ZERO

Note

It is the responsibility of the user to ensure that a zero procedure has recently been done on the transducer, otherwise there will be no recent, valid zero value for the instrument to use, which may result

in inaccurate measurement results.

Zero Calibration of Transducer

Select CH1, the system will zero IBP1. Select CH2, the system will zero IBP2.

Cautions:

- Turn off animal stopcock before you start the zero procedure.
- The transducer must be vented to atmospheric pressure before the zero procedure.
- The transducer should be placed at the same height level with the heart, approximately mid-axially line.
- Zero procedure should be performed before starting the monitoring and at least once a day after each disconnect-and-connect of the cable.

The prompt information related to zero, take CH1 for example.

- "SENSOR OFF, FAIL"
Make sure that transducer is not off, then proceed zeroing.
- "IN DEMO FAIL"
Make sure that the monitor is not in DEMO mode. Contact service technician if necessary.
- "PRESSURE OVER RANGE, FAIL"
Make sure that the stopcock is vented to atmosphere. If there is still problem, contact with service technician.
- "PULSATILE PRESSURE, FAIL"
Make sure that the transducer is not attached to the animal and that the stopcock is vented to atmosphere. If there is still problem, contact with service technician.

IBP Calibration

Press the IBP PRESSURE CALIBRATION button on the IBP SELECT menu to call up the IBP PRESSURE CALIBRATE menu as shown below:



Picture 11-1 IBP Calibration Menu

Calibrate the transducer:

Turn the knob to select the item CH1 CAL VALUE, press and turn the knob to select the pressure value to be calibrated for channel 1. Then turn the knob to select the item CALIBRATE to start calibrating channel 1.

Turn the knob to select the item CH2 CAL VALUE, press and turn the knob to select the pressure value to be calibrated for channel 2. Then turn the knob to select the item CALIBRATE to start calibrating channel 2.

■ The pressure calibration of the monitor

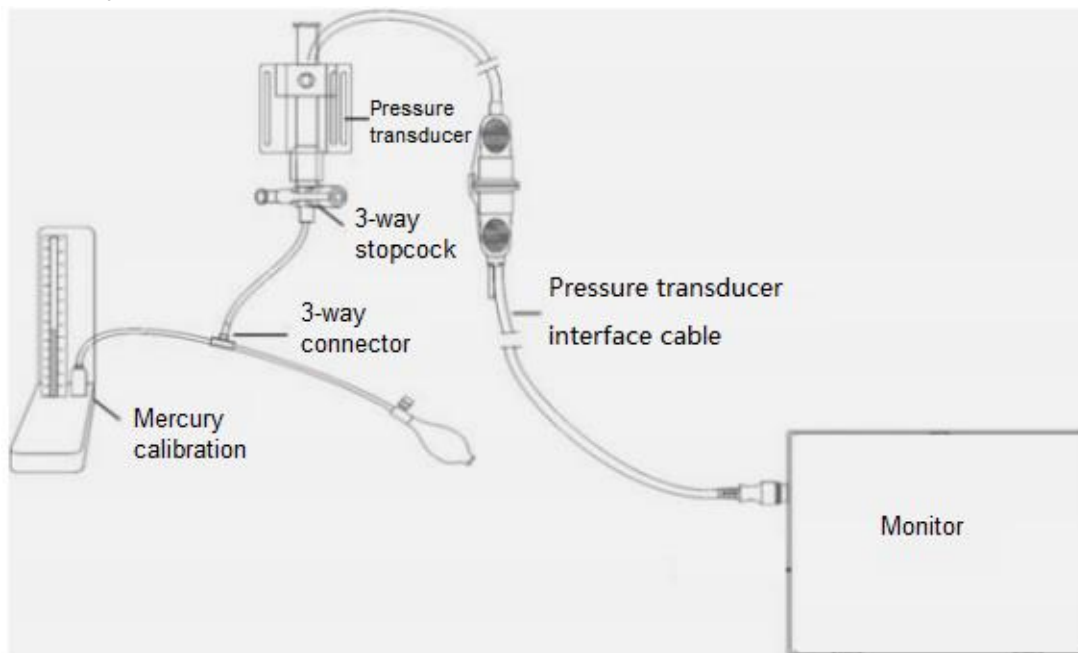

Picture 11-2 IBP Calibration

Caution:

- Mercury calibration should be performed by the biomedical engineering department either whenever a new transducer is used, or as frequently as dictated by your Hospital Procedures Policy.
- The purpose of the calibration is to ensure that the system gives you accurate measurements.
- Before starting a mercury calibration, a zero procedure must be performed.
- If you need to perform this procedure yourself you will need the following pieces of equipment:
 - Standard sphygmomanometer
 - 3-way stopcock
 - Tubing approximately 25 cm long

The Calibration Procedure: (refer to Picture 0-2)

⚠ Warning ⚠

You must never perform this procedure while animal is being monitored.

1. Close the stopcock that was open to atmospheric pressure for the zero calibration.
2. Attach the tubing to the sphygmomanometer.
3. Ensure that connection that would lead to animal is off.

4. Connect the 3-way connector to the 3-way stopcock that is not connected to the animal catheter.
5. Open the port of the 3-way stopcock to the sphygmomanometer.
6. Select the channel to be calibrated in the menu and select the pressure value to which the IBP is to be adjusted.
7. Inflate to make the mercury bar rise to the setup pressure value.
8. Adjust repeatedly until the value in the menu is equal to the pressure value shown by the mercury calibration.
9. Press the Start button, the device will begin calibrating.
10. Wait for the calibrated result. You should take corresponding measures based on the prompt information.
11. After calibration, disassemble the blood pressure tubing and the attached 3-way valve.

If the following messages prompt up, refer to relevant instructions (take channel-1 for instance):

- “SENSOR OFF , FALL”
Make sure that sensor is not off, then proceed calibration.
- “IN DEMO, FAIL”
Make sure that the monitor is not in DEMO mode. Contact service technician if necessary.
- “PRESSURE OVER RANGE, FAIL”
Make sure that you have selected transducer value in IBP CAL, then proceed calibration.

Changing the Label

- IBP SCALE ADJUST submenu:



Picture 11-3 IBP SCALE ADJUST Menu

The waveform and corresponding scale appears in the IBP Waveform Area with 3 dotted lines representing High Limit Scale, Reference Scale, and Low Limit Scale from the top to the bottom. Values of the three scales can be user-set according to the instruction given below.

- IBP label: selectable from ART, PA, CVP, RAP, LAP, ICP, P1, P2;
- HI: IBP value of High Limit scale, the range is the measuring range of the current pressure



The HI value must be higher than the LO value.

- LO: IBP value of Low Limit scale, the range is the measuring range of the current pressure.



The LO value must be lower than the HI value.

- VAL: IBP value of Reference scale (between HI and LO).



When change HI scale, Low scale or Reference scale of IBP waveform and the corresponding IBP waveforms are displayed under the menu window, the waveform will come penetratingly through the menu window for observing.

12.5 Alarm Information and Prompts

Alarm Messages

Among physiological alarms, those belonging to the type that the parameter has exceeded the limits may activate the recorder to automatically output the parameters and related measured waveforms when the alarms occur on the condition that the alarm record switch in the related menu is On.

Tables below describe the possible physiological alarms, technical alarms and prompt messages occurring during IBP measurement.

Physiological alarms:

Message	Cause	Alarm Level
IS1 TOO HIGH	SYS measuring value of channel 1 is above upper alarm limit.	User-selectable
IS1 TOO LOW	SYS measuring value of channel 1 is below lower alarm limit.	User-selectable
ID1 TOO HIGH	DIA measuring value of channel 1 is above upper alarm limit.	User-selectable
ID1 TOO LOW	DIA measuring value of channel 1 is below lower alarm limit.	User-selectable
IM1 TOO HIGH	MAP measuring value of channel 1 is above upper alarm limit.	User-selectable
IM1 TOO LOW	MAP measuring value of channel 1 is below lower alarm limit.	User-selectable

User Manual for Multi-parameter Veterinary Monitor

IS2 TOO HIGH	SYS measuring value of channel 2 is above upper alarm limit.	User-selectable
IS2 TOO LOW	SYS measuring value of channel 2 is below lower alarm limit.	User-selectable
ID2 TOO HIGH	DIA measuring value of channel 2 is above upper alarm limit.	User-selectable
ID2 TOO LOW	DIA measuring value of channel 2 is below lower alarm limit.	User-selectable
IM2 TOO HIGH	MAP measuring value of channel 2 is above upper alarm limit.	User-selectable
IM2 TOO LOW	MAP measuring value of channel 2 is below lower alarm limit.	User-selectable

Technical alarms:

Message	Cause	Alarm Level	Remedy
IBP1 SENSOR OFF	IBP cable of channel 1 falls off from monitor.	LOW	Make sure that cable is properly connected.
IBP2 SENSOR OFF	IBP cable of channel 2 falls off from monitor.	LOW	Make sure that cable is properly connected.
IBP(1,2) INIT ERR	IBP module failure	HIGH	Stop using measuring function of IBP module, notify biomedical engineer or Our service staff.
IBP(1,2) INIT ERR1			
IBP(1,2) INIT ERR2			
IBP(1,2) INIT ERR3			
IBP(1,2) INIT ERR4			
IBP(1,2) INIT ERR5			
IBP(1,2) INIT ERR6			
IBP(1,2) INIT ERR7			
IBP(1,2) INIT ERR8			
IBP(1,2) COMM STOP	IBP(1,2) module failure or communication failure	HIGH	Stop using measuring function of IBP module, notify biomedical engineer or Our service staff.
IBP(1,2) COMM ERR	IBP(1,2)	HIGH	Stop using measuring function of IBP module, notify biomedical engineer or

	communication error		Our service staff.
IBP1 ALM LMT ERR	Functional failure	safety	HIGH
IBP2 ALM LMT ERR	Functional failure	safety	HIGH

Prompt message (general alerts):

Message	Cause	Alarm Level
IBP1 SYS EXCEED	Systolic measuring value of channel 1 is beyond measurement range.	HIGH
IBP1 DIA EXCEED	Diastolic measuring value of channel 1 is beyond measurement range.	HIGH
IBP1 MEAN EXCEED	Mean measuring value of channel 1 is beyond measurement range.	HIGH
IBP2 SYS EXCEED	Systolic measuring value of channel 2 is beyond measurement range.	HIGH
IBP2 DIA EXCEED	Diastolic measuring value of channel 2 is beyond measurement range.	HIGH
IBP2 MEAN EXCEED	Mean measuring value of channel 2 is beyond measurement range.	HIGH
IBP1 NEED ZERO-CAL	Zero calibrating must be done before measuring in IBP channel 1.	LOW
IBP2 NEED ZERO-CAL	Zero calibrating must be done before measuring in IBP channel2.	LOW

12.6 Maintenance and Cleaning

Care and Cleaning



Warning

Before cleaning the monitor or the transducer, make sure that the equipment is switched off and disconnected from the power line.

Cleaning of IBP Transducer (Reusable)

After the IBP monitoring operation is completed, remove the tubing and the dome from the transducer and wipe the transducer diaphragm with water. Soaking and/or wiping with soap can clean the transducer and cable and water or cleaning agents such as those listed below:

Cetylclide

Wavicide-01

Wescodyne

Cidex

Lysol

Vesphene

Do not immerse the connector in any liquid. After cleaning, dry the transducer thoroughly before storing. Slight discoloration or temporary increase of surface stickiness of the cable should not be considered abnormal. If adhesive tape residue must be removed from the transducer cable, double seal tape remover is effective and will cause a minimum of damage to the cable if used sparingly. Acetone, Alcohol, Ammonia and Chloroform, or other strong solvents are not recommended because over time the vinyl cabling will be damaged by these agents.



The disposable transducers or domes must not be re-sterilized or re-used.



For protecting environment, the disposable transducers or domes must be recycled or disposed of properly.

Sterilization

■ Liquid Chemical Sterilization

Remove obvious contamination by using the cleaning procedure described previously. Select a sterilant that your hospital or institution has found to be effective for liquid chemical sterilization of operating room equipment. Buffered glutaraldehyde (e.g. Cidex or Hospisept) has been found to be effective. Do not use quaternary cationic detergents such as zephiran chloride. If the whole unit is to be sterilized, immerse the transducer but not the electrical connector into the sterilant for the recommended sterilizing period. Be sure that the dome is removed. Then rinse all transducer parts except the electrical connector with sterilized water or saline. The transducer must be thoroughly dried before storing.

■ Gas Sterilization

For more complete asepsis, use gas sterilization.

Remove obvious contamination by using the cleaning procedure described previously. To inhibit the formation of ethylene glycol when ethylene oxide gas is used as the disinfectant, the transducer should be completely dry.

Follow the operating instructions provided by the manufacturer of the gas disinfectant.



The sterilize temperature must not exceed 70° C (158° F). Plastics in the pressure transducer may deform or melt above this temperature.

Chapter Thirteen CO2 Measuring (Optional)

13.1 General

This chapter offers some relevant data concerning CO2 monitoring.

The monitor provides one kind of CO2 measuring method, which is SideStream.

This module can be applied in operation room, monitor units etc, it can measure the CO2 partial pressure or concentration of animal Air Way, obtain EtCO₂, Inspired Maximum CO₂ (InsCO₂), Air Way Respiration Rate (AwRR), and display CO₂ concentration waveforms. The parameter symbols displayed on the screen are defined as following:

CO₂: EtCO₂

INS: InsCO₂

AWRR: Air Way Respiration (AwRR)(Resp. times/MIN)

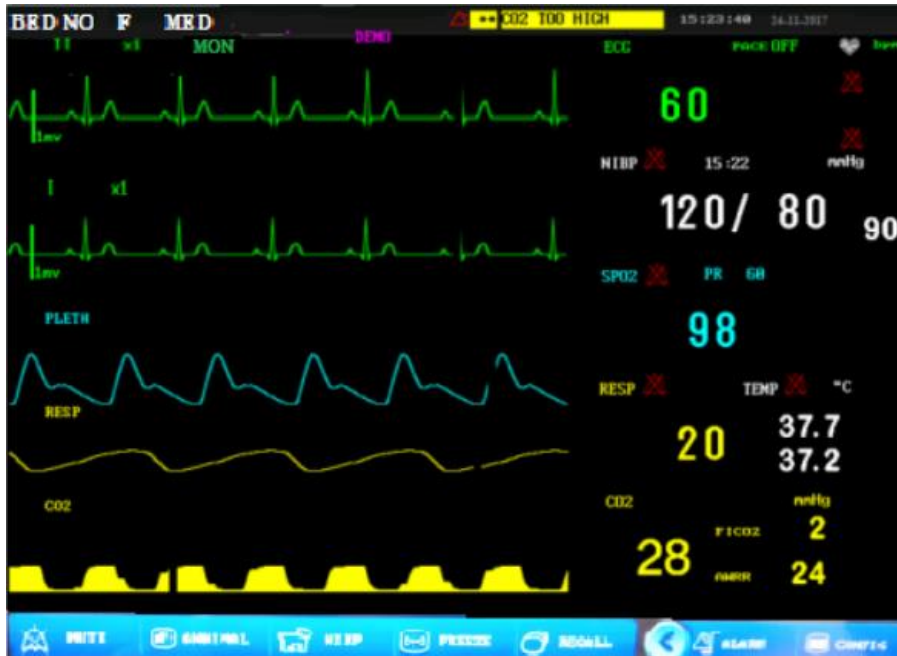

Picture 13-1 The CO2 display

⚠️Note⚠️

Don't use the device in the environment with flammable anesthetic gas.

The device can only be operated by personnel having taken professional training and familiar with this manual.

⚠️Warning⚠️

CO2 module shall be avoided from crash and vibration.

13.2 Monitoring Procedure

CO₂ measurement principle is based on the CO₂ absorption wavelength for 4.3um infrared characteristics carried. The measuring method of the CO₂ gas supplied to the measuring chamber side with the infrared irradiation, and the other side with a sensor measuring the acceptable degree of attenuation of infrared rays, the degree of attenuation is proportional to the concentration of CO₂.

CO₂ partial pressure and CO₂ concentration conversion relationship:

CO₂ partial pressure (mmHg) = CO₂ concentration (%) * Pamp (ambient pressure mmHg) / 100

CO₂ partial pressure (kPa) = CO₂ points pressure (mmHg) / 7.5

CO₂ measurement setups:

1. Insert the sampling tube into the CO₂ jack which is on the side panel of the monitor, and then connect the nasal tube.
2. In the menu, choose “CO₂ setup” , change the “operating mode” to “measurement” , on the screen, it will appear “CO₂ module is running” .
3. After start, in the screen it will appear “CO₂ module is warming up” , then the module is in precision measurement state.
4. After warming up, the module will come into the full precision measurement state.

When the instrument is turned on, the CO₂ module's default mode of operation "to" standby ", the user breath" operating mode "is set to" measure "to start the CO₂ module. Instrument restarts, will remain before the last shutdown "mode of operation, that if the shutdown is selected measurement, the next time you turn on the CO₂ module will automatically enter the measurement mode. More information, see "mode of operation" Other Settings section 13.3 of carbon dioxide menu chapter.

- If the packaging has been opened or damaged parts, internal, please do not use this accessory, and returned to the supplier
- “CO₂ WARM UP” or “CO₂ SENSOR START UP” displayed on the screen indicates that the sensor is in warm-up or starting-up. When the module is warming-up, the module can measure the CO₂ value, but it is not standard value. After the information disappears from the screen, the standard measurement can then be generated.
- Keep sampling tube apart from its socket when not in use.
- Nothing except sampling tube should be inserted to sampling tube socket of CO₂ Module.
- Please insert the sampling tube before connecting the nasal tube to breathing circuit. □
- Please ensure the nasal tube is removed from breathing circuit before pulling out sampling tube.
- Sampling tube is one-off consumables that can not be repeatedly used by different animals.

13.3 CO₂ Menu

13.3.1 Parameter Setup and Adjustment

Turn the knob to select and press CO₂ hot key on the screen to activate “CO₂ Setup” menu as shown below:



Picture 13-2 CO2 Setup Menu

Following functions can be realized via CO2 SETUP menu.

- **ALM**: select “ON” to enable and store alarm prompt when CO₂ parameters have alarms. Select “OFF” to disable alarm and display  beside CO₂. The default is “ON”.
- **ALM REC**: select “ON” to generate output from the recorder ever since CO₂ parameter alarm occurs. The default is “OFF”.
- **ALM LEV**: select from HIGH, MED and LOW. Level HIGH represents the most serious alarm, followed by Level MED and Level LOW with a decrease of seriousness. Change in “ALM LEV” can only affect the physiological alarm levels of CO₂ parameters including EtCO₂ upper limit, EtCO₂ lower limit, InsCO₂ upper limit, AwRR upper limit and AwRR lower limit. The default alarm level is “MED”.
- **CO₂ ALM HI**: to adjust the upper alarm limit of EtCO₂. If the measuring value is larger than CO₂ upper alarm limit, “CO₂ TOO HIGH” appears on the screen. After the measuring value returns to the normal one, the information disappears.
- **CO₂ ALM LO**: to adjust the lower alarm limit of EtCO₂. If the measuring value is smaller than CO₂ lower alarm limit, “CO₂ TOO LOW” appears on the screen. After the measuring value returns to the normal one, the information disappears.
- **INS ALM HI**: to adjust the upper alarm limit of InsCO₂. If the measuring value is larger than InsCO₂ upper alarm limit, “INS TOO HIGH” appears on the screen. After the measuring value returns to the normal one, the information disappears.
- **AWRR ALM HI**: to adjust the upper alarm limit of AwRR. If the measuring value is larger than the upper alarm limit of AwRR, “AWRR TOO HIGH” appears on the screen. After the measuring value returns to the

normal one, the information disappears.

- **AWRR ALM LO:** to adjust the lower alarm limit of AwRR. If the measuring value is smaller than the lower alarm limit of AwRR, “AWRR TOO LOW” appears on the screen. After the measuring value returns to the normal one, the information disappears.
- **UNIT:** to change the display units of CO2 and InsCO2 parameters. “mmHg” and “kPa” are available for selection.
- **SWEEP:** to adjust the display rate of CO2 waveforms with “6.25 mm/s”, “12.5 mm/s”, or “25.0 mm/s” selectable.
- **Exit:** to close CO2 SETUP menu.

⚠Note⚠

“APNEA ALM” cannot be closed.

When various alarms occur simultaneously, the alarm information of highest level will be displayed on the screen.

13.3.2 CO2 other step

pick this item in the menu to call up CO2 more setup sub-menu.



Picture 13-3 More Setups Menu

Now we introduce you to the functions of each item in CO2 SETUP submenu.

- **WAVE SCALE:** to adjust full scale size of CO2 waveform display area with “LOW” or “HIGH” selectable. The default value is “LOW”.

- **WORK MODE:** to change the work mode of CO2 with “MEASURE” mode or “STANDBY” mode selectable.

⚠Note⚠

When not using CO2 monitoring function, it is suggested not to connect SideStream sampling tube and to adjust to “STANDBY” mode.

- **CO2 COMPEN:** to perform compensate operations as per the selection of the user.
- **BALANCE GAS:** ROOM AIR, N2O, HELIUM.
- **Anaesthesia Agent:** The intensity of the Anaesthesia Agent
- **GAS TEMP:** Current Temperature of the gas
- **Barometric:** Current Atmospheric Pressure
- **ETCO2 Period:** The period to calculate the ETCO2, Per breath, 10s, 20s
- **To perform the ZERO.** The usage of the module will be display in the MENU.



Picture 13-4 CO2 ZERO Menu

⚠Note⚠

1. **If Compensate item is not correctly set as per the operation conditions, the result will be far from the actual value, thus leading to severe misdiagnosis.**
2. **The default of Water Vapor Compensate is on. Turn it off when measuring dry gas, such as when performing regular maintenance or measurement validation by using dry calibrated gas.**
3. **The default of BTPS is on. Turn it on when measuring the VA saturated “damp” gas under the body temperature and ambient pressure and turn it off when measuring the “dry” gas under the ambient temperature and pressure.**
4. **Operate by strictly observing the Compensate operation method.**

- **DEFAULT:** pick this item to access the CO2 DEFAULT CONFIG dialog box, in which the user may select whether the **FACTORY DEFAULT CONFIG** or the **USER DEFAULT CONFIG** is to be used. After selecting any of the items and exiting the dialog box, the system will pop up the dialog box asking for the user’s confirmation.

EtCO₂ upper alarm limit: when parameter value exceeds this limit, there will be alarm for exceeding the upper limit.

Default:

Large animals: 50 mmHg

Medium-sized animals: 50 mmHg

Small animals: 45 mmHg

EtCO₂ lower alarm limit: when parameter value is smaller than the lower limit, there will be alarm for exceeding lower limit.

Default:

Large animals: 15 mmHg

Medium-sized animals: 20 mmHg

Small animals: 30 mmHg

InsCO₂ upper alarm limit: when parameter value exceeds this limit, there will be alarm for exceeding upper limit.

Default:

Large animals: 4 mmHg

Medium-sized animals: 4 mmHg

Small animals: 4 mmHg

AwRR upper alarm limit: when parameter value exceeds this limit, there will be alarm for exceeding upper limit.

Default:

Large animals: 30 rpm

Medium-sized animals: 30 rpm

Small animals: 100 rpm

AwRR lower alarm limit: when parameter value is smaller than the limit, there will be alarm for exceeding lower limit.

Default:

Large animals: 8 rpm

Medium-sized animals: 8 rpm

Small animals: 30 rpm

APNEA Time: Selections are 10S to 40S,

Default: 20S.

Work Mode: MainStream: Standby, Measurement;

SideStream: Standby, Measurement.

Default: Measurement

Compensate Method:

MainStream: General/O₂/N₂O/DES/ALL

SideStream: General/O₂/N₂O/DES/ALL

Default Methods: General.

Pump Rate: 100 – 200 ml/min.

Default: 100 ml/min

Unit: mmHg/kPa.

Default: mmHg

Waveform Sweep: 25.0/12.5/6.25 (mm/s)

Default: 25.0 mm/s

Waveform Scale: LOW/HIGH

Default: LOW

Besides, for alarm function of CO2 module, refer to Chapter Alarm, for its recording function, refer to Chapter Recording, and for information about alarm event review, graphic and tabular trend of CO2 parameters, refer to Chapter Trend and Event.

13.4 Alarm Information and Prompt

Among physiological alarms, those belonging to the type that the parameter has exceeded the limits may activate the recorder to automatically output the parameters and related measured waveforms when the alarms occur on the condition that the alarm record switch in the related menu is On.

Tables below describe the possible physiological alarms, technical alarms and prompt messages occurring during CO2 measurement.

Physiological alarms:

Message	Cause	Alarm Level
CO2 TOO HIGH	EtCO2 measuring value is above upper alarm limit.	User-selectable
CO2 TOO LOW	EtCO2 measuring value is below lower alarm limit.	User-selectable
INS TOO HIGH	InsCO2 measuring value is above alarm limits.	User-selectable
AWRR TOO HIGH	AwRR measuring value is above upper alarm limit.	User-selectable
AWRR TOO LOW	AwRR measuring value is below lower alarm limit.	User-selectable
CO2 APNEA	In specific time interval, no RESP can be detected using CO2 module.	HIGH

Technical alarms:

Message	Cause	Alarm Level	Remedy
CO2 CHECK THE SAMPLING TUBE	the sampling tube is plugged	LOW	replace the sampling tube
CO2 SIGNAL LOW	Measuring module technical failure	LOW	If necessary, re-start the monitor. If failure persists, stop using measuring function of CO2 module, notify biomedical engineer or Our service staff.
CO2 SIGNAL TOO LOW		LOW	
CO2 BAROMETRIC TOO LARGE		MED	
CO2 PNEUMATIC LEAK		MED	

CO2 SIGNAL NOISY		LOW	
CO2 SIGNAL SATURATE		LOW	
CO2 CALCULATION ERR		HIGH	
CO2 SENSOR FAULT		HIGH	
CO2 SENSOR TEMP HIGH		HIGH	
CO2 SENSOR TEMP LOW		HIGH	
CO2 WATCHDOG TIMEOUT		HIGH	
CO2 INT COMM ERR		HIGH	
CO2 SYSTEM ROM ERR		HIGH	
CO2 FLASH CRC ERR		HIGH	
CO2 INT RAM ERR		HIGH	
CO2 FLASH CHECK ERR		HIGH	
CO2 EXT RAM ERR		HIGH	
CO2 STACK OVER		HIGH	
CO2 PUMP FAULT		HIGH	
CO2 REVERSE FLOW		HIGH	
CO2 FORWARD FLOW		HIGH	
CO2 MALFUNCTION		HIGH	
CO2 BAROMETRIC HIGH		HIGH	
CO2 BAROMETRIC LOW		HIGH	
CO2 COMM ERR	CO2 module communication failure	HIGH	Stop using measuring function of CO2 module,notify biomedical engineer or Our service staff.
CO2 INIT ERR	CO2 module is not properly connected or failed.	HIGH	Stop using measuring function of CO2 module,notify biomedical engineer or Our service staff.
CO2 COMM STOP	Measuring module failure or communication failure.	HIGH	Stop using measuring function of CO2 module,notify biomedical engineer or Our service staff.
CO2 ALM LMT ERR	Functional safety failure	HIGH	Stop using measuring

INS ALM LMT ERR	Functional safety failure	HIGH	function of CO2 module, notify biomedical engineer or Our service staff.
AWRR ALM LMT ERR	Functional safety failure	HIGH	

Prompt message:

Message	Cause	Alarm Level
CO2 STANDBY STATUS	Turn from measuring mode to standby mode, making the module in energy-saving status.	No alarm
CO2 WARM UP	Shows that the sensor is in warming-up stage.	No alarm
CO2 SENSOR START UP	Shows that the sensor has just entering start-up stage.	No alarm

13.5 Maintenance and Cleaning

■ Care and Maintenance

1. Sample tube is for one-off use in SideStream module. Do not sterilize or clean for reuse on another animal.
2. Please keep the sampling tube clean, dust isolated, in case of any stoppage. It is suggested to replace sampling tube every 12 hours (Using time could extend to 120 hours when the sampling tube be used with a filter), or change the sampling tube when any leaks, damage or pollution found.
3. No routine calibration required in Sidestream CO2 module.

Manufacturer's Declaration of the EUT

Guidance and manufacturer's declaration – electromagnetic emission – for all EQUIPMENT AND SYSTEMS

1	Guidance and manufacturer's declaration – electromagnetic emission		
2	The Plug-in Type Veterinary Monitor is intended for use in the electromagnetic environment specified below. The customer or the user of Plug-in Type Veterinary Monitor should assure that it is used in such an environment.		
3	Emissions test	Compliance	Electromagnetic environment - guidance
4	RF emissions CISPR 11	Group 1	The Plug-in Type Veterinary Monitor uses RF energy only for its internal function. Therefore, its RF emissions are very low and are not likely to cause any interference in nearby electronic equipment.
5	RF emissions CISPR 11	Class A	The Plug-in Type Veterinary Monitor is suitable for use in all establishments other than domestic, and may be used in domestic establishments and those directly connected to the public low-voltage power supply network that supplies buildings used for domestic purposes, provided the following warning is heeded.
6	Harmonic emissions IEC 61000-3-2	Class A	
7	Voltage fluctuations / flicker emissions IEC 61000-3-3	Complies	

Guidance and manufacturer's declaration – electromagnetic immunity – for all EQUIPMENT and SYSTEMS

Guidance and manufacturer's declaration – electromagnetic immunity			
The Plug-in Type Veterinary Monitor is intended for use in the electromagnetic environment specified below. The customer or the user of the Plug-in Type Veterinary Monitor should assure that it is used in such an environment.			
Immunity test	IEC 60601 test level	Compliance level	Electromagnetic environment - guidance
Electrostatic discharge (ESD) IEC 61000-4-2	± 6 kV contact ± 8 kV air	± 6 kV contact ± 8 kV air	Floors should be wood, concrete or ceramic tile. If floors are covered with synthetic material, the relative humidity should be at least 30 %.

Electrostatic transient / burst IEC 61000-4-4	± 2 kV for power supply lines ± 1 kV for input/output lines	± 2 kV for power supply lines	Mains power quality should be that of a typical commercial or hospital environment.
Surge IEC 61000-4-5	± 1 kV differential mode ± 2 kV common mode	± 1 kV differential mode ± 2 kV common mode	Mains power quality should be that of a typical commercial or hospital environment.
Voltage dips, short interruptions and voltage variations on power supply input lines IEC 61000-4-11	< 5 % UT (>95 % dip in UT) for 0.5 cycle 40 % UT (60 % dip in UT) for 5 cycles 70 % UT (30 % dip in UT) for 25 cycles < 5 % UT (>95 % dip in UT) for 5 sec	< 5 % UT (>95 % dip in UT) for 0,5 cycle 40 % UT (60 % dip in UT) for 5 cycles 70 % UT (30 % dip in UT) for 25 cycles < 5 % UT (>95 % dip in UT) for 5 sec	Mains power quality should be that of a typical commercial or hospital environment. If the user of the Plug-in Type Veterinary Monitor requires continued operation during power mains interruptions, it is recommended that the Plug-in Type Veterinary Monitor be powered from an uninterruptible power supply or a battery.
Power frequency (50/60 Hz) magnetic field IEC 61000-4-8	3 A/m	3 A/m	Power frequency magnetic fields should be at levels characteristic of a typical location in a typical commercial or hospital environment.
NOTE U_T is the a. c. mains voltage prior to application of the test level.			

**Guidance and manufacturer's declaration – electromagnetic immunity –
for EQUIPMENT and SYSTEM that are not LIFE-SUPPORTING**

Guidance and manufacturer's declaration – electromagnetic immunity			
The Plug-in Type Veterinary Monitor is intended for use in the electromagnetic environment specified below. The customer or the user of the Plug-in Type Veterinary Monitor should assure that it is used in such an environment.			
Immunity test	IEC 60601 test level	Compliance level	Electromagnetic environment - guidance

<p>Conducted RF</p>	<p>3 Vrms</p>	<p>3 Vrms</p>	<p>Portable and mobile RF communications equipment should be used no closer to any part of the Plug-in Type Veterinary Monitor, including cables, than the recommended separation distance calculated from the equation applicable to the frequency of the transmitter.</p>
<p>IEC 61000-4-6</p>	<p>150 kHz to 80 MHz</p>		<p>Recommended separation distance</p> $d = \left[\frac{3.5}{V_1} \right] \sqrt{P}$ $d = \left[\frac{3.5}{E_1} \right] \sqrt{P} \quad 80 \text{ MHz to } 800 \text{ MHz}$ $d = \left[\frac{7}{E_1} \right] \sqrt{P} \quad 800 \text{ MHz to } 2.5 \text{ GHz}$
<p>Radiated RF</p>	<p>3 V/m</p>	<p>3 V/m</p>	<p>where p is the maximum output power rating of the transmitter in watts (W) according to the transmitter manufacturer and d is the recommended separation distance in metres (m).^b</p> <p>Field strengths from fixed RF transmitters, as determined by an electromagnetic site survey,^a should be less than the compliance level in each frequency range.^b</p> <p>Interference may occur in the vicinity of equipment marked with the following symbol:</p> 

NOTE 1 At 80 MHz and 800 MHz, the higher frequency range applies.

NOTE 2 These guidelines may not apply in all situations. Electromagnetic is affected by absorption and reflection from structures, objects and people.

^a Field strengths from fixed transmitters, such as base stations for radio (cellular/cordless) telephones and land mobile radios, amateur radio, AM and FM radio broadcast and TV broadcast cannot be predicted theoretically with accuracy. To assess the electromagnetic environment due to fixed RF transmitters, an electromagnetic site survey should be considered. If the measured field strength in the location in which the Plug-in Type Veterinary Monitor is used exceeds the applicable RF compliance level above, the Plug-in Type Veterinary Monitor should be observed to verify normal operation. If abnormal performance is observed, additional measures may be necessary, such as re-orienting or relocating the Plug-in Type Veterinary Monitor.

^b Over the frequency range 150 kHz to 80 MHz, field strengths should be less than 3V/m.

**Recommended separation distances between portable and mobile
RF communications equipment and the EQUIPMENT or SYSTEM -
for EQUIPMENT and SYSTEMS that are not LIFE-SUPPORTING**

Recommended separation distances between portable and mobile RF communications equipment and the Plug-in Type Veterinary Monitor			
<p>The Plug-in Type Veterinary Monitor is intended for use in an electromagnetic environment in which radiated RF disturbances are controlled. The customer or the user of the Plug-in Type Veterinary Monitor can help prevent electromagnetic interference by maintaining a minimum distance between portable and mobile RF communications equipment (transmitters) and the Plug-in Type Veterinary Monitor as recommended below, according to the maximum output power of the communications equipment.</p>			
Rated maximum output of transmitter W	Separation distance according to frequency of transmitter m		
	150 kHz to 80 MHz $d = [\frac{3.5}{V_1}] \sqrt{P}$	80 MHz to 800 MHz $d = [\frac{3.5}{E_1}] \sqrt{P}$	800 MHz to 2.5 GHz $d = [\frac{7}{E_1}] \sqrt{P}$
0.01	0.12	0.12	0.23
0.1	0.38	0.38	0.73
1	1.2	1.2	2.3
10	3.8	3.8	7.3
100	12	12	23
<p>For transmitters rated at a maximum output power not listed above the recommended separation distance d in metres (m) can be estimated using the equation applicable to the frequency of the transmitter, where P is the maximum output power rating of the transmitter in watts (W) according to the transmitter manufacturer.</p> <p>NOTE 1 At 80 MHz and 800 MHz, the separation distance for the higher frequency range applies.</p> <p>NOTE 2 These guidelines may not apply in all situations. Electromagnetic propagation is affected by absorption and reflection from structures, objects and people.</p>			

Appendix I: Product Specification

I.1 ECG Specification

I.1.1 Lead configuration

Standard 3-lead or 5-lead

3-lead RA、LA、LL, Lead method: I, II, III

5-lead RA、LA、LL、RL、V, Lead method: I, II, III, aVR, aVL, aVF, V

I.1.2 Increase

×250, ×500, ×1000, ×2000

I.1.3 HR

Range

Large animals 15 ~ 300bpm (beat/minute)

Medium-sized animals/ Small animals 15 ~ 350 bpm(beat/minute)

Precision ±1% or ±1bpm, the larger prevails

Resolution 1 bpm(beat/minute)

I.1.4 Sensitivity

> 200 uV (Peak-to-peak value)

I.1.5 Input Impedance

> 5 (megohm)

I.1.6 Bandwidth

Diagnostic mode 0.05~130Hz

Monitoring Mode 0.5~40Hz

Operation mode 1~20Hz

I.1.7 Common Mode rejection Ratio

Diagnostic mode > 90 dB

Monitoring Mode > 100 dB

Operation mode > 100 dB

I.1.8 Pole Polarization Vvoltage Range

±300mV

I.1.9 Pacing Pulse Test

Test pacing pulse in accordance with the following conditions:

Amplitude: ±2 mV ~ ±700mV

Width: 0.1ms ~ 2ms

Risetime: 10us~100us

I.1.10 Pacing pulse inhibition

When pacing analysis switch is on, pacing pulse in accordance with the following conditions are restrained, but affection against HR calculation.

Amplitude: $\pm 2 \text{ mV} \sim \pm 700 \text{ mV}$

Width: $0.1 \text{ ms} \sim 2 \text{ ms}$

Risetime: $10 \mu\text{s} \sim 100 \mu\text{s}$

I.1.11 Baseline Recovering Time

After defibrillation < 3 seconds

I.1.12 Signal Range

$\pm 8 \text{ mV}$ (Peak-to-peak value)

I.1.13 Calibrating Signal

1 mV (Peak-to-peak value), precision $\pm 5\%$

I.1.14 ST Segment Measuring Volume

Measuring range: $-2.0 \text{ mV} \sim +2.0 \text{ mV}$

Measuring precision: Ranging $-0.8 \text{ mV} \sim +0.8 \text{ mV}$, measuring error is $\pm 0.02 \text{ mV}$ or $\pm 10\%$. The larger prevails.

No definition for other ranges.

I.2 RESP Specification

I.2.1 Measuring Method

RA-LL impedance

I.2.2 RESP Impedance Measuring Range

$0.3 \sim 3 \Omega$

I.2.3 Base Impedance Range

$200 \sim 4000 \Omega$

I.2.4 Bandwidth

$0.1 \sim 2.5 \text{ Hz}$

I.2.5 RESP Rate

Range

Large animals $0 \sim 120 \text{ BrPM}$

Medium-sized animals/ Small animals $0 \sim 150 \text{ BrPM}$

Resolution 1 BrPM

Precision $\pm 2 \text{ BrPM}$

I.2.6 Asphyxia Alarm

10~40 seconds

I.3 NIBP Specification

I.3.1 Measuring Method

Pulse wave oscillometry

I.3.2 Work Mode

Manual/Automatic/STAT

I.3.3 Measuring Interval of Automatic Measuring Mode

1,2,3,4,5,10,15,30,60,90,120,180,240,480 minute(s)

I.3.4 Measuring Time of STAT Mode

5 minutes

I.3.5 PR range

40 – 240 bpm

I.3.6 Measuring Range and Precision

Range

Large animals	Systolic blood pressure	40~270mmHg
	Diastolic blood pressure	10~215mmHg
	Mean blood pressure	20~235mmHg
Medium-sized animals	Systolic blood pressure	40~200mmHg
	Diastolic blood pressure	10~150mmHg
	Mean blood pressure	20~165mmHg
Small animals	Systolic blood pressure	40~135mmHg
	Diastolic blood pressure	10~100mmHg
	Mean blood pressure	20~110mmHg

Static pressure range 0~300mmHg

Static pressure precision ± 3 mmHg

Pressure precision: Max. average error: ± 5 mmHg; Max. standard deviation: ± 8 mmHg

I.3.7 Overvoltage protection

Large animals mode 300 mmHg

Medium-sized animals mode 240 mmHg

Small animals mode 150 mmHg

I.4 SpO2 Specification

I.4.1 SpO2

Range	0~100%
Resolution	1%
Precision	70~100%: ± 2 DIGIT 0%~69%: no definition given

I.4.2 PR

Range	20~300bpm
Resolution	1bpm
Precision	± 3 bpm

I.5 TEMP Specification

I.5.1 suitable for temperature sensor

YSI series, CYF series

I.5.2 Channel quantity

2 channels

I.5.3 Measuring

Range	0~50°C
Resolution	0.1°C
Precision	± 0.1 °C (excluding sensor error)

I.6 IBP Specification

Label ART, PA, CVP, RAP, LAP, ICP, P1, P2

Measuring and alarm range

ART	0 ~ 300 mmHg
PA	-6 ~ 120 mmHg
CVP/RAP/LAP/ICP	-10 ~ 40 mmHg
P1/P2	-10 ~ 300 mmHg

Press Sensor

Sensitivity	5 uV/V/mmHg
Impedance	300-3000 Ω
Resolution	1 mmHg
Accuracy	$\pm 2\%$ or ± 1 mmHg, which great
Actualization interval	about 1 Sec.

I.7 CO2 Specification

I.7.1 Side stream:

Warm-up time

When the ambient temperature is 25 °C, the carbon dioxide curve (capnogram) can be displayed within 20

seconds, and all the specifications can be fulfilled within 2 minutes.

Measurement range

0-150mmHg,0-19.7%,0-20kPa (at 760mmHg), atmospheric pressure provided by the host.

Resolution

0.1mmHg : 0-69mmHg 0.25mmHg: 70-150mmHg

Precision

0-40mmHg: ± 2 mmHg
41-70mmHg: $\pm 5\%$ (reading)
71-100mmHg: $\pm 8\%$ (reading)
101-150mmHg: $\pm 10\%$ (reading)

Respiratory rate range

0- 150 BPM

Respiratory rate accuracy:

± 1 BPM.

1.7.2 Main stream:

Warm-up time

When the ambient temperature is 25 °C, the carbon dioxide curve (capnogram) can be displayed within 15 seconds, and all the specifications can be fulfilled within 2 minutes.

Measurement range

0-150mmHg,0-19.7%,0-20kPa (at 760mmHg), atmospheric pressure provided by the host.

Resolution

0.1mmHg : 0-69mmHg 0.25mmHg: 70-150mmHg

Precision

0-40mmHg: ± 2 mmHg
41-70mmHg: $\pm 5\%$ (reading)
71-100mmHg: $\pm 8\%$ (reading)
101-150mmHg: $\pm 10\%$ (reading)

Respiratory rate range

0- 150 BPM

Respiratory rate accuracy:

± 1 BPM.